



**MALMET (AUSTRALIA)  
PTY LTD**

Head Office and Customer Service  
ABN 95 001 717 791

9-11 McKay Avenue  
PO Box 373  
Leeton NSW 2705

Phone: +61 2 6953 7677  
Email: [info@malmet.com.au](mailto:info@malmet.com.au)

# ***Bedpan/Urinal Bottle and Utensil/Bowl Washer Disinfector***

Models WDS1; WDS3



## ***Operation, Maintenance and Installation Manual***

**Note: Due to Malmet's Policy of continuous product improvement;  
design and technical specifications are subject to change without notice.**

<b>Serial Number:</b>	<b>Supplied to:</b>
<b>Date Installed:</b>	<b>Installed by:</b>

It is important that the name from whom you purchased your device and the name of the installer are recorded above. The installer is responsible for the correct installation, start up and demonstrating the operation of this device. They are also responsible for issuing relevant certificates of compliance (these may differ from state to state).



## Table of Contents

Foreword .....	2
Certifications and Compliances.....	2
Quality Policy.....	2
Important Warranty Reminder .....	2
Malmet Head Office and Factory Contact Details .....	2
Safety Instructions – Warnings .....	3
Intended Use .....	4
1.0 Design Parameters.....	4
1.1 Operating Cycles .....	5
1.2 Chemical Dosing System.....	6
1.3 Detergent.....	6
1.4 Device Features.....	8
1.5 Control LCD Display Features .....	8
1.6 Operating Features .....	9
2.0 Installation and Commissioning.....	10
2.1 Installation .....	10
2.2 Service Connections.....	11
2.3 Plumbing Connections .....	11
2.4 Venting.....	13
2.5 Electrical.....	13
2.6 Service Connection Points .....	14
2.7 Device Dimensions.....	15
2.8 Commissioning (To only be completed by qualified persons) .....	16
3.0 Loading and Operation.....	17
3.1 Urinal Bottle / Bedpan – Loading (Refer to laminated quick reference instructions) .....	17
3.2 Urinal Bottle / Bedpan – Operating Cycle (Refer to laminated quick reference instructions) .....	18
3.3 Urinal Bottle Only – Loading (Refer to laminated quick reference instructions).....	19
3.4 Urinal Bottle Only – Operating Cycle (Refer to laminated quick reference instructions).....	19
3.5 Bowl / Utensil – Loading (Refer to laminated quick reference instructions).....	20
3.6 Bowl / Utensil – Operating Cycle (Refer to laminated quick reference instructions).....	21
4.0 Cycle of Operation .....	22
4.1 Release of Processed items .....	27
5.0 Maintenance .....	27
5.1 Daily Maintenance (Operator or Maintenance Technician) .....	27
5.2 Bi-Monthly Maintenance (Maintenance Technician).....	27
5.3 Recommended Preventative Maintenance Schedule (to be performed by qualified maintenance personnel).....	28
5.4 Post Maintenance or Repair Safety Checks.....	29
5.5 Door Safety Test .....	29
5.6 Cycle Operation Check.....	29
5.7 Post Maintenance and Repair of Electrical Systems .....	29
5.8 Replacement of Safety Devices .....	29
5.9 Validation.....	30
5.10 Requalification.....	30
5.11 Device faults.....	31
5.12 Fault Indication .....	31
5.13 Fault Codes.....	31
5.15 Making equipment safe after incomplete operating cycle .....	34
5.16 Purge Reset (Operator).....	34
5.17 Purge Detergent Line (Operator).....	34
5.18 Manual Purge Reset (Maintenance).....	35
5.19 Manual Purge Detergent Line (Maintenance).....	35
5.20 Safe Access to the Load or Chamber in Fault Condition.....	36
6.0 Technical Data .....	37
6.1 Power and Water Consumption .....	37
6.2 Device Specifications .....	38
6.3 Wiring Diagram (1ph devices) Manufactured after June 2020 .....	40
6.3 Wiring Diagram (1ph devices) Manufactured before June 2020 .....	41
6.4 Wiring Diagram (3ph devices) Manufactured after June 2020 .....	42
6.4 Wiring Diagram (3ph devices) Manufactured before June 2020 .....	43
Warranty Statement .....	44



## Foreword

In order to obtain maximum life and efficiency from your Malmet Bedpan/Urinal Bottle and Utensil/Bowl Washer Disinfectant and to aid in the safe operation of the device, please read and understand this manual thoroughly and follow all instructions before operating.

This device is not intended for use by persons (including children) with reduced physical, sensory or mental capabilities, or lack of experience and knowledge.

Children should be supervised to ensure that they do not play with the device.

The specifications supplied in this manual were in effect at time of publication, however due to Malmet (Australia)'s policy of continuous improvement, changes to these specifications may be made at any time without notice on the part of Malmet (Australia) Pty Ltd.

## Certifications and Compliances

ARTG Identifier: 232450

Electrical Safety Cert: Cert No. CS10462N IEC61010-2-040 in conjunction with IEC61010-1

EMC Compliance: Cert No: M1910013

Watermark Cert: Cert No: WMKA21156

## Quality Policy

Malmet's quality management system is certified to ISO 13485 and ISO 9001 and guarantees the quality of this device.

## Important Warranty Reminder

Should you have any problems with your device, contact the company from whom you purchased it, or Malmet (Australia) Pty Ltd.

It is important that the name from whom you purchased your device and the name of the installer are recorded on the front page of this manual. The installer is responsible for the correct installation, start up and demonstrating the operation of this device. They are also responsible for issuing relevant certificates of compliance (these may differ from state to state).

## Malmet Head Office and Factory Contact Details

### Malmet (Australia) Pty Ltd

9-11 McKay Avenue  
PO Box 373  
LEETON NSW 2705

Telephone: +61 2 6953 7677













E-mail: [info@malmet.com.au](mailto:info@malmet.com.au)

Website: [www.malmet.com.au](http://www.malmet.com.au)

## Safety Instructions – Warnings

*Please read and understand this manual before using this device, if this device is used in a manner not specified by the manufacturer protection by the device may be impaired.*

Please refer to this manual for information wherever this warning symbol is displayed – 

-  **Be aware of 240V / 415V Voltage**
-  **Disconnect power when servicing**
-  **Mains power ISO switch must be in an accessible position easily reached and not obstructed so device can be isolated from mains power during service**
-  **For the safe use of this device the responsible body should ensure that all operators are adequately trained to operate and maintain the device in its safe use.**
-  **Only process items listed as per the design parameters in this manual**
-  **Be aware of steam discharge**
-  **Utensils and racks are hot to handle**
-  **Safety gloves and goggles must be worn when changing detergent**
-  **Safety clothing with reflective tape can activate the hands-free sensor when device is in standby mode**
-  **Be aware of hot surfaces, pipes and hoses from steam and hot water**
-  **Install temperature probes and element over temperature thermal cut-outs correctly**
-  **Plumbing service connection must comply with AS/NZS 3500.1 and AS/NZS 3500.2**
-  **Not suitable for use in the presence of flammable anaesthetic mixtures with air or nitrous oxide and mode of operation as continuous**



## Intended Use

The Malmet Bedpan / Urinal Bottle and utensil/Bowl Washer Disinfector is intended to be used by health service organisation personnel for the cleaning and disinfection of medical devices during an automatic cycle of the types intended to be re-used as listed in the design parameters section of this manual.

### 1.0 Design Parameters

The Malmet Bedpan/Urinal Bottle and Utensil/Bowl Washer Disinfector has been designed within the following parameters:

- a) To empty, clean and disinfect devices of the type listed below intended to be re-used and that have been soiled by human excreta. \*
- b) To clean and disinfect during each automatic cycle a load comprised of the following re-useable medical devices.
  - i) Standard size bedpans
  - ii) Standard male and female urinal bottles
  - iii) 300mm/255mm/220mm/160mm Kidney dishes
  - iv) 345mm/305mm/240mm/210mm/185mm/140mm/110mm/100mm/80mm bowls, dishes and receivers.
- c) Two bedpans with lids and four urinal bottles can be emptied, cleaned and disinfected during an automatic cycle.
- d) The cradle is designed to ensure that re-useable medical devices are not dislodged during the cleaning cycle. The contents are emptied during door closure.
- e) The chamber and door are self-cleaning and do not permit water or soil to remain after a properly completed cycle. Steam disinfecting ensures all internal surfaces are totally clean and safe.
- f) The bedpan flush cycle:
  - i) Removes the heavy soil
  - ii) Clears the trap
- g) Disinfection cycle is factory pre-set to 90° for 1 minute, to achieve an A<sub>0</sub> of 600 in accordance with AS 5369:2023, Section 6.3, Table 6.1.

\*The efficacy of disinfection can be impaired if soil removal is incomplete before the start of the disinfection process. Users should be aware that some medical devices might require pre-treatment such as soaking or brushing before processing. Please follow the manufacturer's instructions when processing re-useable medical devices.

\*\*High disinfection temperatures may affect some heat sensitive reusable medical devices; ensure items are disinfected as per the manufacturer's instructions.

\*Non-flushable items such as Feminine Hygiene products, Incontinence or Absorbent pads & diapers, Condoms, Dental Floss, Paper Towel, Cigarette butts, medications or chemicals cannot be disposed of in Malmet Washer Disinfectors and should be disposed as per facility &/or local waste management requirements.

## 1.1 Operating Cycles

Three available operating (cleaning and disinfection)



Urinal Bottle / Bedpan

Load: capacity: 2 x small slipper pans, 2 x large slipper pans, 2 x standard bedpans and 4 x standard male and female urinal bottles

Cycle:

- |    |                               |               |
|----|-------------------------------|---------------|
| 1. | Flush                         | 8 to 12 sec   |
| 2. | Cold water wash               | 25 to 35 sec  |
| 3. | Hot water wash with detergent | 10 to 15 sec  |
| 4. | Hot water rinse               | 25 to 35 sec  |
| 5. | Disinfection                  | 1 min at 90°C |
| 6. | Cool down                     | 20 sec        |



Urinal Bottle only

Load capacity: 4 x Standard male and female urinal bottles

Cycle:

- |    |                               |               |
|----|-------------------------------|---------------|
| 1. | Cold water wash               | 40 to 50 sec  |
| 2. | Hot water wash with detergent | 40 to 50 sec  |
| 3. | Hot water rinse               | 25 to 35 sec  |
| 4. | Disinfection                  | 1 min at 90°C |
| 5. | Cool down                     | 20 sec        |



Bowl / Utensil

Load capacity: 2 x large bowls (345Dia to 305Dia), 3 x medium bowls (240Dia to 210Dia), 6 kidney dishes (sizes 300 x 50, 255 x 50 and 220 x 43 – held in kidney rack holder)

Smaller kidney dishes fit into a basket with a smaller open-ended trays and utensils.

Cycle:

- |    |                               |               |
|----|-------------------------------|---------------|
| 1. | Cold water wash               | 40 to 50 sec  |
| 2. | Hot water wash with detergent | 40 to 50 sec  |
| 3. | Hot water rinse               | 25 to 35 sec  |
| 4. | Disinfection                  | 1 min at 90°C |
| 5. | Cool down                     | 20 sec        |



Note: These times do not include filling and heating.

In accordance and complies with:

Cleaning Efficacy  
AS 5369, ISO 15883-1, ISO 15883-5

Thermal Disinfection  
AS 5369, ISO 15883-1

## 1.2 Chemical Dosing System

The chemical dosing system ensures the correct amount of process chemicals are delivered at the correct stage during each operating cycle. Chemical addition is controlled by the automatic cycle controller and will display a fault if the incorrect amount of chemical is injected. The dosing system is designed for use with Malmet Chemical; other chemicals may impair the operation of the system.

## 1.3 Detergent

Malmet Washer Disinfectors are designed and tested using Malmet specific detergent. To ensure intended performance and trouble-free operation use only Malmet branded detergent, failure to use correct detergent may void warranty.

The detergent system delivers 30ml of concentrated detergent during the Hot Water Wash stage.

### Changing the detergent bottle



### **SAFETY GLOVES AND GOGGLES MUST BE WORN WHEN CHANGING DETERGENT AND DISPOSING OF EMPTY CONTAINERS**

Current Safety Data Sheet for Malmet detergent is available in .PDF format from Malmet's website. [www.malmet.com.au](http://www.malmet.com.au)

The 5-litre detergent container is accessed by opening the bottom door. Only use Malmet approved detergent (See technical data for detergent details)

1. Pull handle on detergent door and open
2. Unscrew cap and pull out with suction hose (let hose hang in detergent chamber)
3. Remove empty bottle and replace with full bottle

**Note: Leave cap on new bottle until in position**

4. Remove cap on new bottle and fit existing hose and cap, make sure suction hose is at bottom of bottle
5. Close detergent door
6. Restart device operation as normal



### **Disposal of Empty Detergent Bottles**

1. When handling empty containers treat as though container is full and wear appropriate PPE as per MSD requirements
2. Triple rinse container and puncture base to render unusable
3. Dispose of containers as per facility chemical waste handling procedures, and/or local government requirements



## Detergent Warnings

If insufficient detergent is available to deliver the required quantity, the device will display a fault 302. Access to the load will be restricted until the condition is rectified.

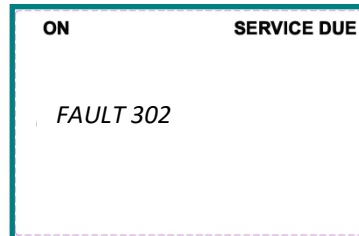
To rectify this fault, install a new detergent bottle as per the procedure in this manual "Changing the Detergent Bottle".



Once a full bottle has been installed the detergent line will require purging

1. Turn power OFF  at control LCD display
2. Turn power ON  at control LCD display

On powering back on the display will show TEST 302



3. The detergent line will automatically purge if necessary for a predetermined time or until the detergent is detected
4. Once detergent is detected the fault will clear and the previous cycle will be restarted

If the detergent fault is not cleared check detergent level and repeat the purge process again, if the detergent fault continues and is unable to be cleared contact maintenance or service provider



### 1.4 Device Features

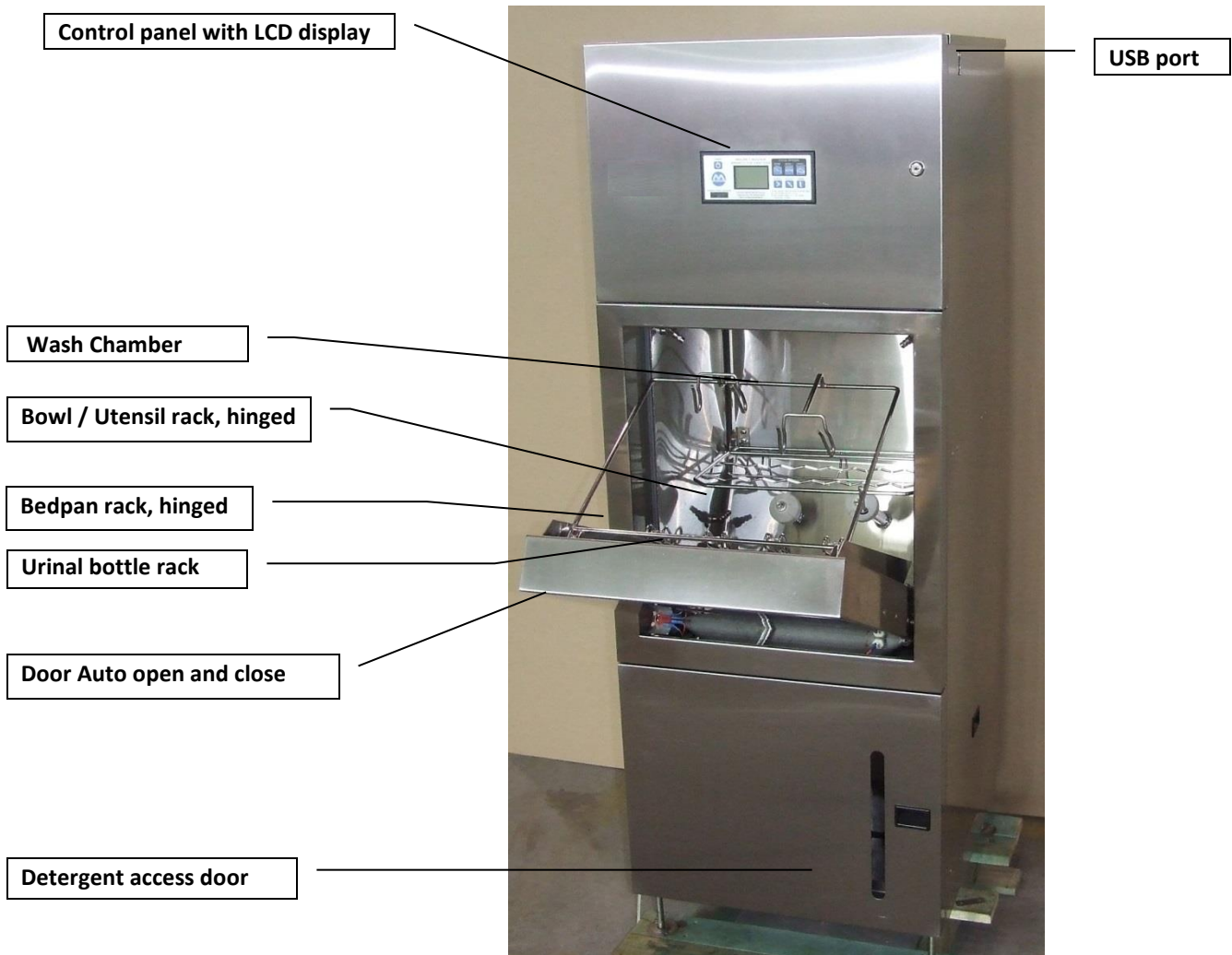

### 1.5 Control LCD Display Features



## 1.6 Operating Features



**POWER**

On/Off Standby



**HANDS FREE SENSOR**

For hands free opening, closing door and starting of cycle. To operate, hold hand in front of sensor



**URINAL BOTTLE ONLY**

Select and start for urinal bottle only cycle



**BOWL / UTENSILS**

Select and start for bowls / kidney dishes etc



**URINAL BOTTLE / BEDPAN**

Select and start for urinal bottles / bedpans



**DOOR**

To manually open and close door, if pressed whilst door is closing at the start of a cycle the cycle will be cancelled and the door opened



**SCROLL**

Menu scroll button SERVICE ONLY



**SELECT**

Menu select and enter button SERVICE ONLY  
Purge Reset: When "purge" is flashing on display, if pressed this will start the purge cycle after a fault.

### Hands free operation



The hands-free option can open and close the door without touching the device

Adjusting the rack position and loading the device accordingly (refer to 3.0 Loading and Operation)

The hands-free option can be used to start the operating cycle

### Manual operation of the door



Press the door button to open the door

Adjust the rack position and load the device accordingly (refer to 3.0 Loading and Operation)

Press the door button to start the operating cycle

## 2.0 Installation and Commissioning

### 2.1 Installation

To avoid problems with this device, these Installation Guidelines should be followed.

Installations must be carried out by a qualified and licenced tradesperson.

The device must be affixed to the building structure to ensure mechanical stability prior to use. The device can be affixed to the building structure via the holes provided in the device feet, or use of an appropriately rated appliance safety strap.

Prior to installation of the device, services as noted are to be provided by the facility. It is not the responsibility of Malmat to provide these service connections.

#### Risk Assessment

It is recommended a risk assessment is conducted by the user both prior to and after installation and any risks identified mitigated to an acceptable level using the hierarchy of control;

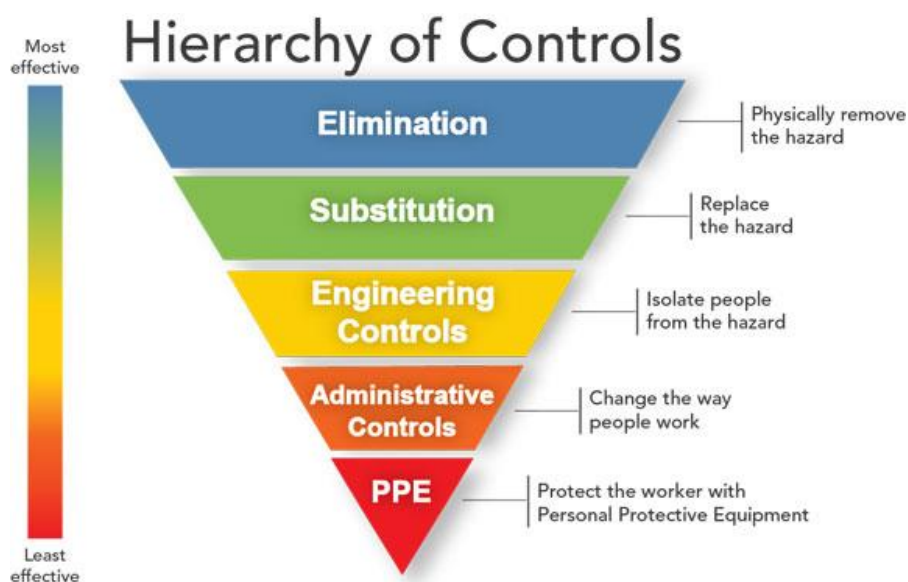

<https://commons.wikimedia.org/w/index.php?curid=55610678>

#### Handling

 Weights of Device: Net: 140 kg Shipping: 165 kg Shipping with crating: 217 kg.

- Handling of the device to installation site must be with fork lift or hand pallet truck.
- Before unpacking device inspect carton for any damage relating to forklift forks and damage relating to device falling over or for evidence of top loading
- After unpacking the device, inspect all external panels for damage.
- Remove the 4 screws holding the device to the pallet.
- Follow your internal manual handling guidelines to manoeuvre the device off the pallet. The device can then be placed into position by fork lift or hand pallet truck.

#### Disposal of Packaging

- Please dispose of packaging as per facility procedures or local government requirements.

#### Disposal of Medical Device

- Please dispose of medical device as per state environmental regulatory requirements.

### 2.1.1 Positioning the WDS

Model	Placement	Access Required	Device Dimensions		
			Height	Width	Depth (mm)
WDS1; WDS3	Freestanding	Both Sides	1695	610	625

Please allow sufficient room for servicing purposes. Minimum recommended clearance of 150mm on either side and 150mm at the rear of the device. Clearances below the recommended measurement can be achieved however additional charges may be incurred for servicing and maintenance of the equipment.

#### New Buildings

- Service connections are usually pre-placed after planning and consultation with all interested parties. Installation is by connection to the services provided.
- As the soil line (sewerage outlet) is the least flexible of all the connections, this usually influences the decision as to where to place the WDS. If an existing soil line can be utilised this will represent a cost saving.
- The WDS is supplied as either a 'S' or 'P' Trap as nominated by the Purchaser. The 'S' Trap connects through the floor and the 'P' Trap connects through the back wall. The trap section is easily removed if the wrong trap has been ordered. Refer to Diagram C2 for trap connections.

 Potential electromagnetic or other interference between other EQUIPMENT and devices can possibly affect the infra-red hands-free operation sensor. It is advisable to check all the equipment and devices in the intended installation area that have infra-red operation. **Electromagnetic interference can be prevented by installing the device in non-patient areas of hospital (or similar).**

### 2.2 Service Connections

MODEL	HOT WATER	COLD WATER	SOIL LINE	ELECTRICAL
WDS1 (1ph)	Solenoid valve GB $\frac{3}{4}$ Male	Solenoid valve GB $\frac{3}{4}$ Male	100mm 'S' or 'P' Trap Hot water discharge 50-55°C	240V 1 Phase 20 Amps 50 Hertz
WDS3 (3ph)	Solenoid valve GB $\frac{3}{4}$ Male	Solenoid valve GB $\frac{3}{4}$ Male	100mm 'S' or 'P' Trap Hot water discharge 50-55°C	415V 3 Phase 20 Amps 50 Hertz

### 2.3 Plumbing Connections



These installation guidelines must be followed to ensure the device will operate as intended.

Installations must be carried out by a qualified, licensed tradesperson.



**Water Supply – Note: Water Supply connections must comply with AS/NZS3500.1 and be Watermark Certified.**

HOT AND COLD-WATER CONNECTIONS ARE REQUIRED. The device can be connected to any potable mains pressure hot and cold-water supply as a back-flow prevention air gap is incorporated in the design of the water tank. Complies to AS 2845.2

**Cold Water – Note:** See device specifications table for water quality requirements

Pressure: 100-350kPa

Temperature: 15-25°C

Nominal Flow: 10L/Min

Connection: GB  $\frac{3}{4}$ " BSP

**Hot Water – Note:** See device specifications table for water quality requirements

Pressure: 100-350kPa

Temperature: 55-65°C

Nominal Flow: 10L/Min

Connection: GB 3/4" BSP

- The water supply is to be connected to an isolating valve or cistern stopcock placed approximately 1200mm from the floor to the right-hand side of the device (preferably not behind the device).
- If inlet water flow pressure is higher than 350 Kpa an inline pressure reducing valve should be fitted

**Note:** Old hose sets should not be re-used; it is recommended new compliant hose sets are used on installation.

### Waste / Soil Line Connection

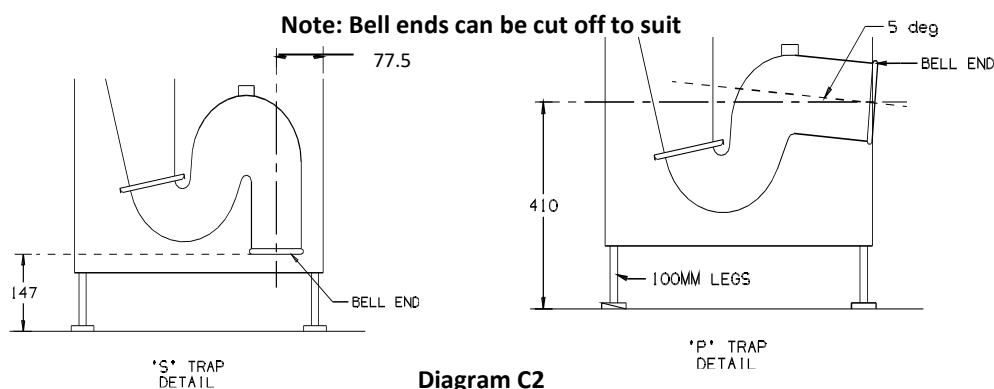

For reasonable connection working space allow 150mm from rear of device to wall.

The device is 610mm wide and the centre of the trap is 305mm from each side.

#### FREE STANDING

##### 'S' TRAP PIPE POSITIONING

For optimal installation, the center of the soil line designated for the 'S' Trap should be positioned at an approximate distance of 227.5mm from the back wall.

Additionally, for adequate side service access, a spacing of 455mm from the soil line to the nearest side wall is advisable. In cases where spatial constraints limit adherence to these recommendations, priority should be given to maximizing space on the right-hand side (as viewed from the front of the device), maintaining a minimum clearance of 150mm. This arrangement is recommended to facilitate easier servicing of the steam tank element and probe, minimizing potential difficulties.

#### FREE STANDING

##### 'P' TRAP PIPE POSITIONING

The centre of the soil line to receive the 'P' Trap should be approximately 410mm from the floor when the device is positioned 150mm from the wall. Because this pipe is graded to 5° this measurement will vary as the device is installed closer or further away from the back wall.

- Hot water Discharge temp 50° – 55°C. Soil line must comply to AS/NZS 3500.2
- Soil line connection is by a pan collar or other preferred method. If the belled end on the polyethylene moulded trap is not required it can easily be cut off to provide a straight pipe connection.
- Level the device by using the flanged screw in legs and, if possible, maintain approx. 100mm floor clearance for ease of floor cleaning. Malmest recommends affixing some of the leg flanges to the floor via stainless self-tapping screws to prevent sideways movements and damage to services and soil line connections.
- The soil line should protrude from the floor or wall at a minimum of 100mm.

## 2.4 Venting

No external vent pipe work is required as the device is designed to condensate all visible steam internally

## 2.5 Electrical



These installation guidelines must be followed to ensure the device will operate as intended and must be carried out by a qualified, licensed electrical tradesperson. The device must be installed and serviced to national wiring rules AS/NZS 3000.

Model: WDS 1ph          240V 50Hz          1 Ph      20Amp

                                 WDS 3ph          415V 50Hz          3 Ph      20Amp



Overcurrent Protection device: A 20A circuit breaker or fuse must be installed in the building installation for the device.

- Devices are supplied with 1700mm power supply cord extending from the rear top right-hand side of the device for hard wiring into Mains ISO switch. Position switch approx. 1500mm above floor level.
- An ISO switch or circuit breaker must be included in the installation (not supplied by Malmel).
- Mains power ISO switch must be suitably located and easily reached, approximately 1500mm above floor level adjacent to device. The 1.7m mains power lead exits the device approximately 1600mm above floor level on the right-hand side of the device.
- Mains ISO switch must be marked as the disconnecting device for the equipment.
- Mains ISO switch must have contact disconnection of all poles to provide full disconnection.
- Mains ISO switch must be suitably placed so device will not obstruct safe access to the isolator once installed.
- Ensure isolator is suitably placed so device will not obstruct safe access to the isolator once installed.
- Device must be earthed.
- Malmel recommends having a 30mA RCD in the mains supply fixed wiring.
- If the supply cord is damaged, it shall be replaced by the manufacturer or its service agent or similarly qualified person in order to avoid any potential hazard.

## 2.6 Service Connection Points

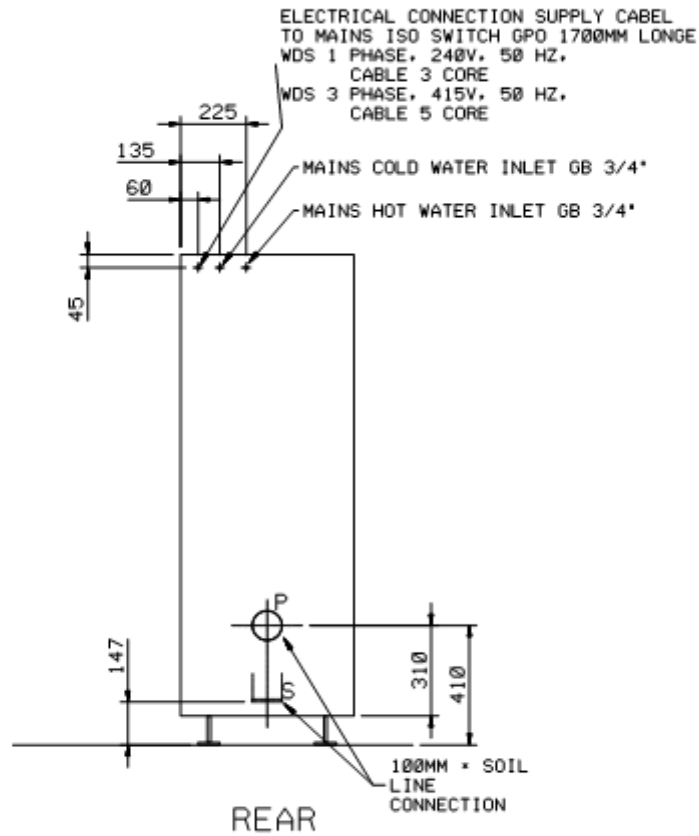

Dimension Tolerance  $\pm 5\text{mm}$

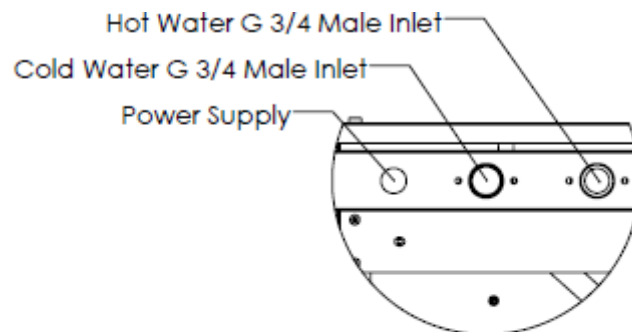

DETAIL A  
 SCALE 1 : 5

## 2.7 Device Dimensions

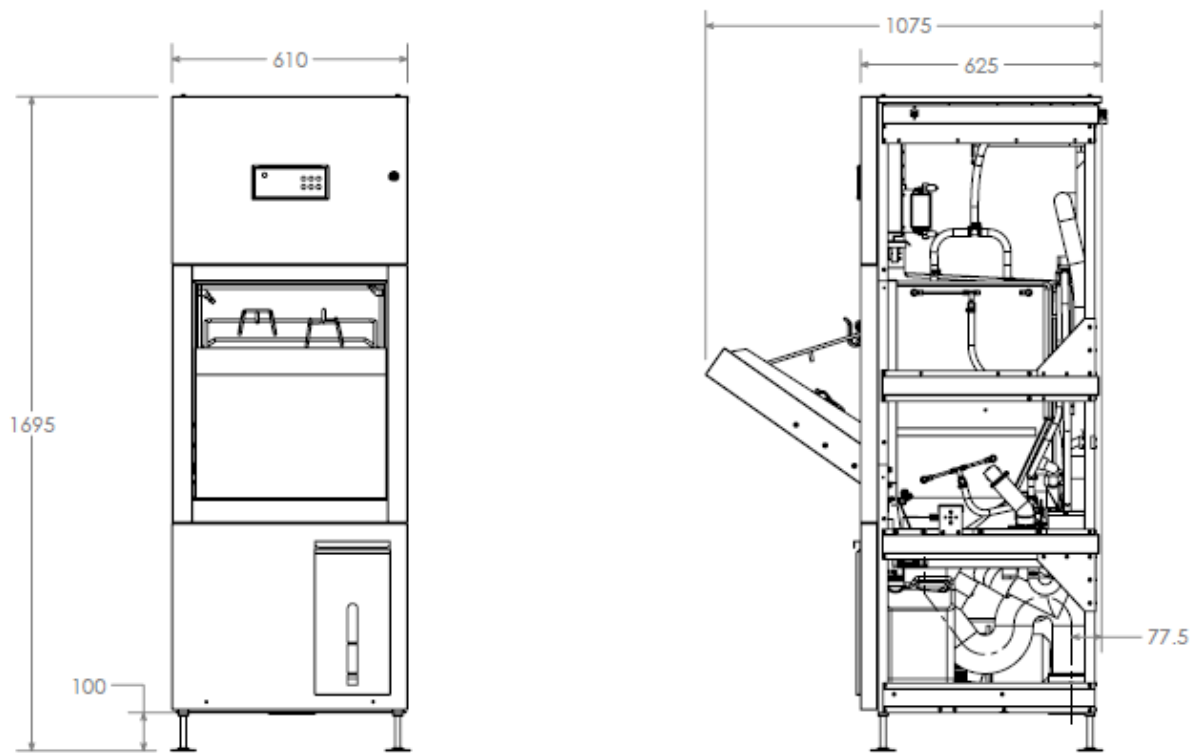

Dimension Tolerance  $\pm 5\text{mm}$

**FRONT VIEW**

**RIGHT VIEW**

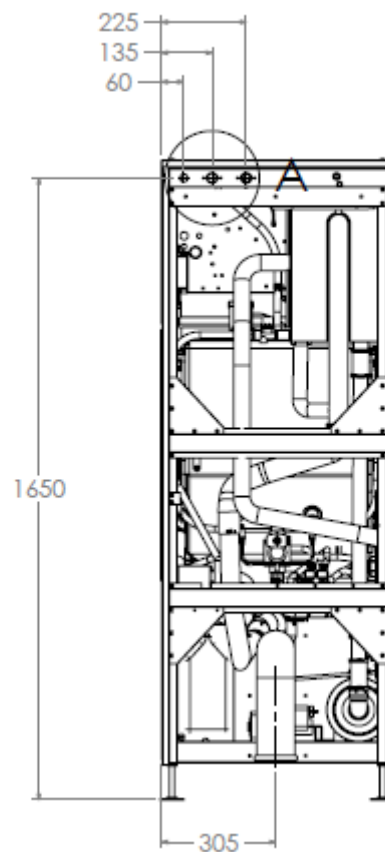

**BACK VIEW**





## **2.8 Commissioning (To only be completed by qualified persons)**



- a) Before switching on the device make sure the DEVICE IS LEVEL and WATER TAPS ARE ON. Check that the DRAIN WASTE is connected.
- b) Turn on the power at the isolation switch and press the standby button on the front display to power on. The LCD display will illuminate and go to standby mode.
- c) Check that the water tank is filling with cold water and that it fills to Level 3. Ensure the lid is put back on water tank.
- d) Check that the steam generator tank has filled to the full Level 3. The steam generator will preheat to 85°C in standby mode or during cycle.
- e) Check that the 5-litre detergent bottle has been fitted. From the menu, run the DETERG/START to purge detergent through the line to flow sensor. This may need to be done twice if the line is empty on start-up (see 5.19).
- f) Flush approximately 1 litre of water down the steam generator tank overflow pipe. This will fill the 'S' Trap at the hose junction and prevent steam coming back up into the water tank.
- g) From the Menu, run Purge Reset three times (see 5.18). Check for any water leaks.
- h) Open the door and turn power off at the control. Check racks for freedom of movement. Check that flush nozzles rotate freely. Check that all spray nozzles are tight. Turn power back on and close door by pressing the door button.
- i) Select the BEDPAN/URINE cycle and let it run through the cycle. Repeat the same procedure for the URINE and BOWL cycles.
- j) Replace all covers.

**Note: DO NOT USE THE DEVICE WITHOUT THE WATER SUPPLY TURNED ON**

### 3.0 Loading and Operation

 For the safe use of this device the responsible body should ensure that all operators are adequately trained to operate and maintain the device in its safe use.

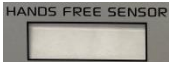
#### 3.1 Urinal Bottle / Bedpan – Loading (Refer to laminated quick reference instructions)

1. To open door, use  press 
2. Place racks into the correct positions

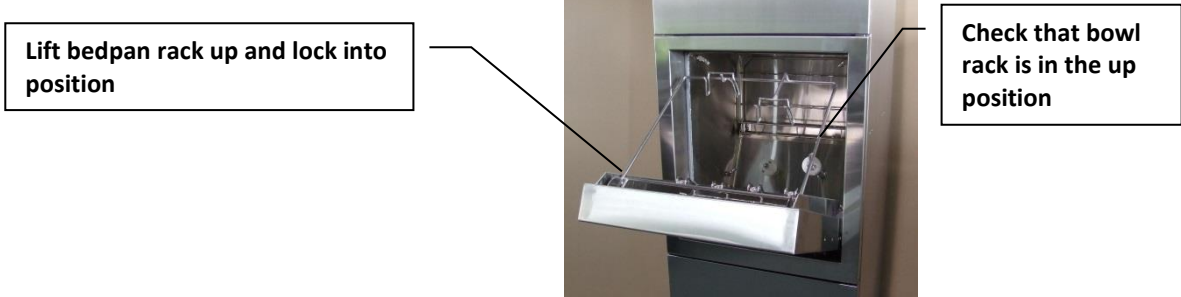

3. Place bedpan lids into back of bowl rack



4. Place first bedpan or large/small slipper pan onto top rack









5. Place second bedpan or large/ small slipper pan onto bottom rack

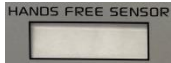

6. Place urinal bottles into rack

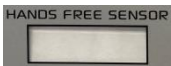

### 3.2 Urinal Bottle / Bedpan – Operating Cycle (Refer to laminated quick reference instructions)

1. Open door, using  or press 
2. Set rack position and load items to be processed as shown in 3.1
3. Select URINE / BEDPAN cycle  to close door & start cycle or
4. Close door, using either the  or press 
5. When the door closes, to start cycle use the  or press  within 10 Seconds whilst “START” is flashing



Cycles stages will be shown on LCD display

1. Flush
  2. Cold water wash
  3. Hot water wash with detergent
  4. Hot water rinse
  5. Disinfection
  6. Cool down
  7. Completed
8. When the cycle is completed the display will flash *COMPLETED OPEN DOOR*

Open door, use the  or press 

NOTE: If temperature inside the chamber is too high the display will flash, *WAITING COOLING*

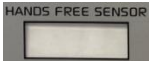
When the temperature has dropped to a safe level the display will flash, *OPEN DOOR*

Open door, use  or press 

To run the same cycle, repeat steps 1 to 3

If you don't need to run another cycle, close door by pressing 



NOTE:



- In an emergency, pressing the Power button  on the top left-hand corner of the display will power off the device.
- On powering up after a cancelled cycle the device will display a Fault code 904 – Power Interrupted (see note below)



NOTE:

- On powering up device will prompt to complete a “Purge Reset”, if the condition that caused the fault has been rectified press “Select” to start the “Purge Reset”. On completion of the “Purge Reset” device will restart previous cycle and will not allow access to the load until cycle has been successfully completed.

### 3.3 Urinal Bottle Only – Loading (Refer to laminated quick reference instructions)

1. Open door, use  or press 
2. Place racks into correct positions

Bedpan rack must be in the down position









Check that the bowl rack is in the up position

3. Place urinal bottles into rack



### 3.4 Urinal Bottle Only – Operating Cycle (Refer to laminated quick reference instructions)

1. Open door, using  or press 
2. Set rack position and load items to be processed as shown in 3.3
3. Select URINE ONLY cycle  to close door & start cycle or
4. Close door, using either  or press 
5. When the door closes, to start the cycle use the  or press  within 10 Seconds whilst "START" is flashing



Cycles will be shown on LCD display

1. Cold water wash
  2. Hot water wash with detergent
  3. Hot water rinse
  4. Disinfection
  5. Cool down
  6. Completed
7. When the cycle is completed the display will flash *COMPLETED OPEN DOOR*

Open door, use  or press 

NOTE: If temperature inside the chamber is too high the display will flash *WAITING COOLING*

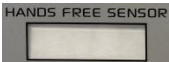
When the temperature has dropped to a safe level the display will flash *OPEN DOOR*

To open door, use  or press 

To run the same cycle, repeat steps 1 to 3

If you don't need to run another cycle close door by pressing 



NOTE:



- In an emergency, pressing the Power button  on the top left-hand corner of the display will power off the device.
- On powering up after a cancelled cycle the device will display a Fault code 904 – Power Interrupted (see note below)



NOTE:

- On powering up device will prompt to complete a “Purge Reset”, if the condition that caused the fault has been rectified press “Select” to start the “Purge Reset”. On completion of the “Purge Reset” device will restart previous cycle and will not allow access to the load until cycle has been successfully completed.

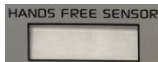
### 3.5 Bowl / Utensil – Loading (Refer to laminated quick reference instructions)

1. Open door, use  or press 
2. Place racks into the correct positions

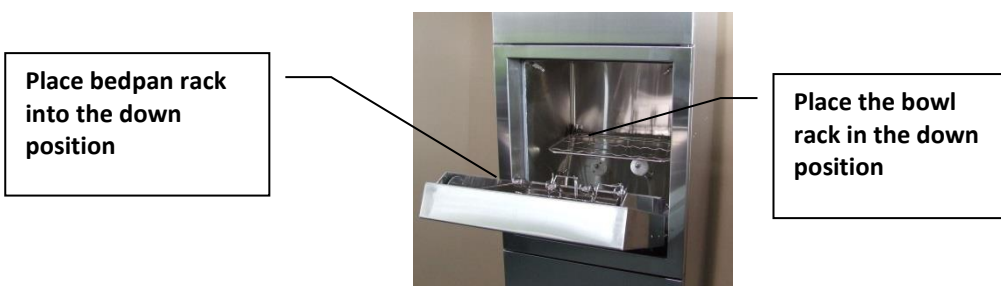

Examples of bowls and utensils placed onto racks

Large and medium size bowls



Medium size kidney dishes  
(Optional accessory Part # 92-5033)

Kidney dish rack placed onto bowl rack



Load kidney dishes into rack







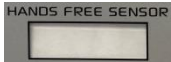

Smaller items can be placed into a basket  
(Optional accessory Part # 92-5235)

Basket placed onto bowl rack

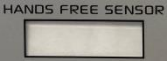

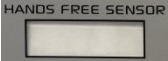

### 3.6 Bowl / Utensil – Operating Cycle (Refer to laminated quick reference instructions)

1. Open door, using  or press 
2. Set rack position and load items to be processed as shown in 3.5
3. Select BOWL / UTENSIL cycle  to close door & start cycle or
4. Close door, using either the  or press 
5. When the door closes, to start the cycle use the  or press  within 10 Seconds whilst "START" is flashing

Cold water wash

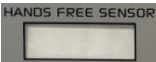

1. Hot water wash with detergent
2. Hot water rinse
3. Disinfection
4. Cool down
5. Complete

When the cycle is completed the display will flash *COMPLETED OPEN DOOR*

5. Open door, use  or press 

NOTE: If temperature inside the chamber is too high the display will flash *WAITING COOLING*

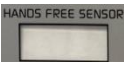
When the temperature has dropped to a safe level the display will flash *OPEN DOOR*

6. To Open door, use  or press 

7. To run the same cycle, repeat steps 1 to 3

8. If you don't need to run another cycle close door by pressing 



NOTE:

In an emergency, pressing the Power button  on the top left-hand corner of the display will power off the device

- On powering up after a cancelled cycle the device will display a Fault code 904 – Power Interrupted (see note below)



NOTE:

- On powering up device will prompt to complete a "Purge Reset", if the condition that caused the fault has been rectified press "Select" to start the "Purge Reset". On completion of the "Purge Reset" device will restart previous cycle and will not allow access to the load until cycle has been successfully completed

## 4.0 Cycle of Operation

1. Press POWER ON button; display shows:

**POWER**



After short delay display shows alternating

**OPEN  
DOOR**

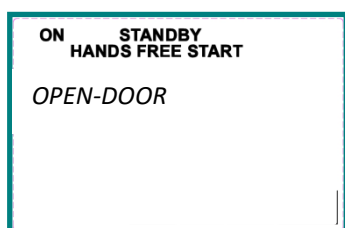

2. Open door; display shows:

**OPENING**

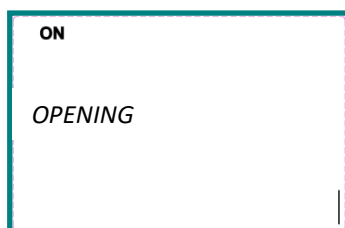

3. When door is open; display shows:

**LOAD  
ITEMS**

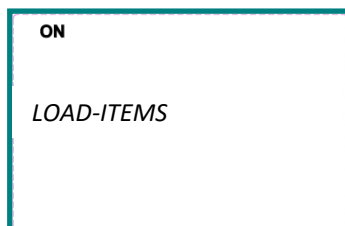

After a short delay, display shows the cycle selection based on the rack positions (Urine, Bedpan & Urine or Bowl)

**SELECT  
CYCLE**

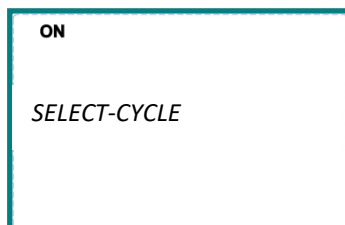

If the wrong cycle has been selected for the position of the racks; an audible alarm will sound and display briefly shows: Check rack position and cycle selected match load type being processed.

**WRONG  
RACK**  
Then  
**SELECT  
CYCLE**





4. After select cycle; display shows:

*CLOSING*

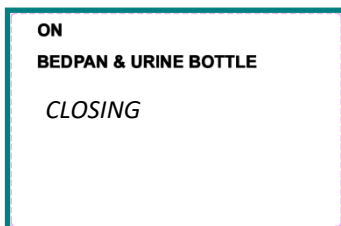

5. Once door is closed using Hands Free or door button; display flashes 'START' for 10 seconds.

*START*

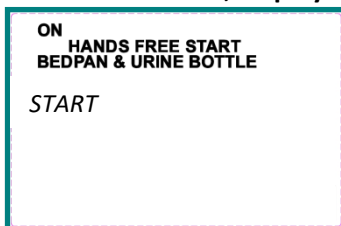

If cycle isn't initiated within this period operation returns to Step 1

6. When door closes via cycle select or cycle initiated in 10 second period; display shows:

**BEDPAN/URINE BOTTLE**  
 CYCLE 1: COLD FLUSH

**URINE ONLY OR BOWL**

*COLD  
 FILL 1*

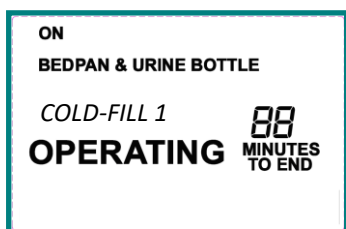

*NOT USED*

When filled to correct level; display shows:

*FLUSH 1*

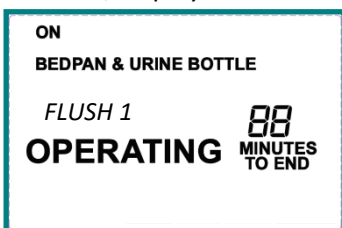

*NOT USED*

Display shows:

**CYCLE 2: COLD WASH**

**CYCLE 1: COLD WASH**

*COLD  
 FILL 2*

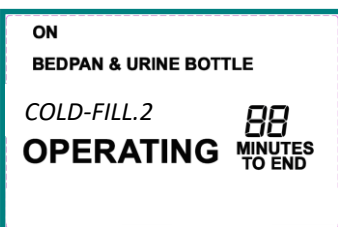

*COLD  
 FILL 1*

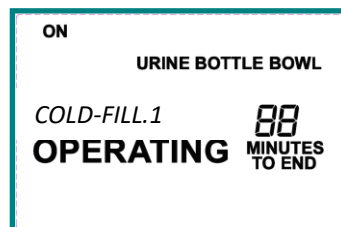

When filled to correct level; display shows:

*COLD  
 WASH 2*

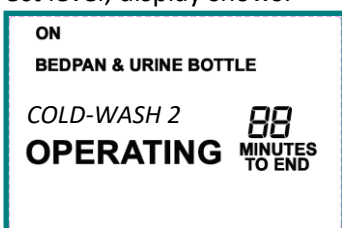

*COLD  
 WASH 1*

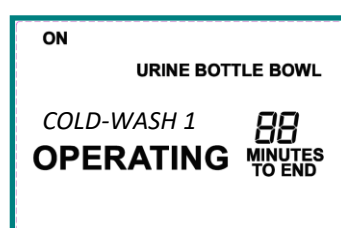





**BEDPAN/URINE BOTTLE**  
 CYCLE 3: HOT WASH PLUS DETERGENT

**URINE ONLY OR BOWL**  
 CYCLE 2: HOT WASH PLUS DETERGENT

Display shows:

**HOT+DET  
 FILL 3**

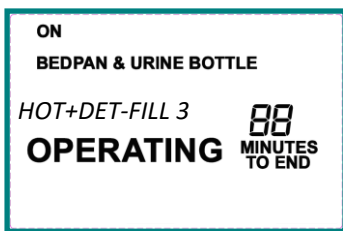

**HOT+DET  
 FILL 2**

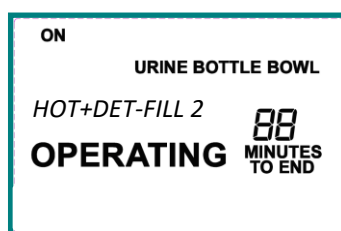

When filled to correct level; display shows:

**HEATING  
 WATER 3**

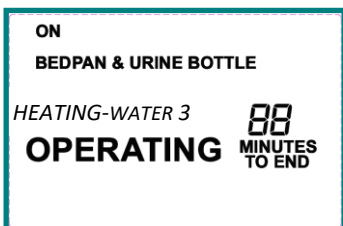

**HEATING  
 WATER 2**

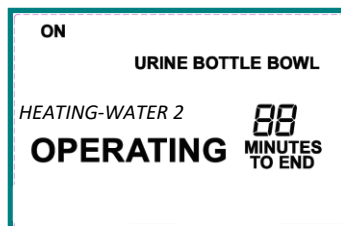

When water reaches temp; display shows:

**HOT+DET  
 WASH 3**

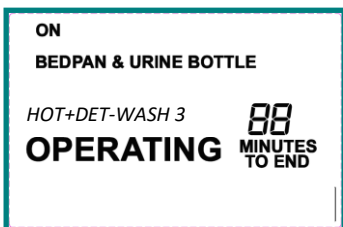

**HOT+DET  
 WASH 2**

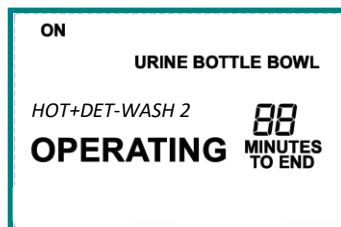

CYCLE 4: HOT RINSE

CYCLE 3: HOT RINSE

Display shows:

**HOT  
 FILL 4**

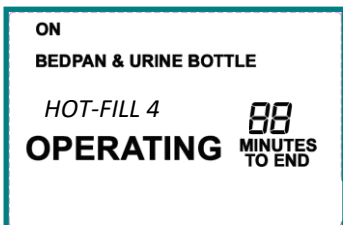

**HOT  
 FILL 3**

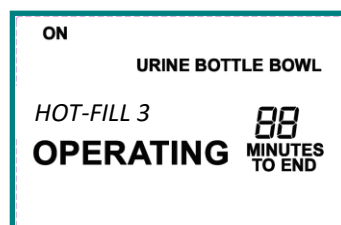

When filled to correct level; display shows:

**HEATING  
 WATER 4**

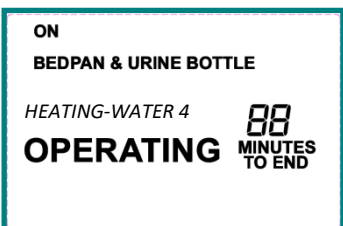

**HEATING  
 WATER 3**

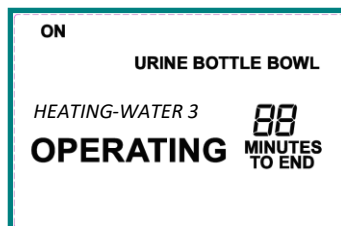

When water reaches temp; display shows:

**HOT  
 RINSE 4**

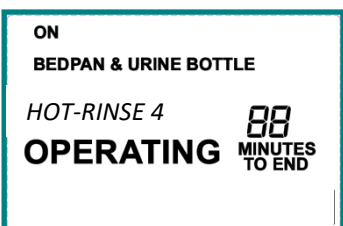

**HOT  
 RINSE 3**

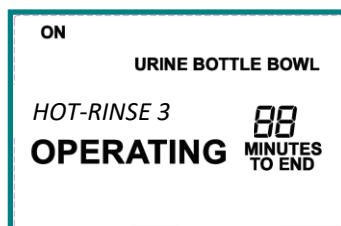



7. Disinfection; display shows:

**TEMP 50° to 93°C**  
 Steam heating chamber to 93°C  
 When chamber reaches 93°C  
 Disinfection for 1 min @ 93°C

**BEDPAN/URINE BOTTLE**

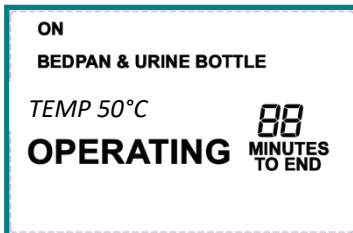

**URINE ONLY OR BOWL**

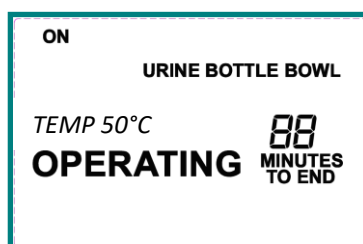

**TEMP 93°C**

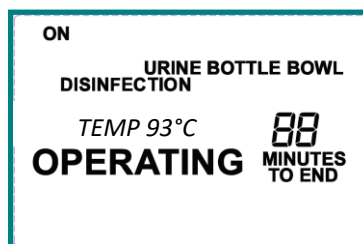
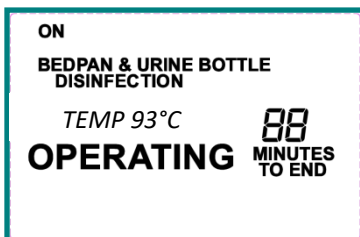

When disinfection completes; display briefly shows:

**SUCCESS**

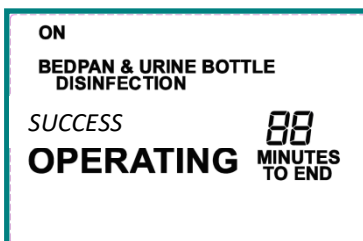

8. Cool Rinse; display shows:

**COOL  
 RINSE**

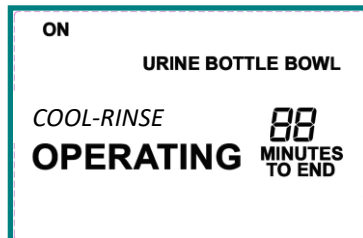
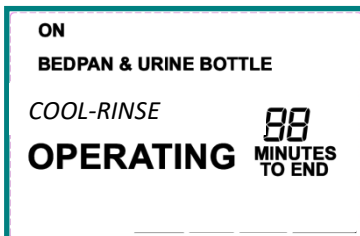

9. Completed; display shows:

**OPEN  
 DOOR**

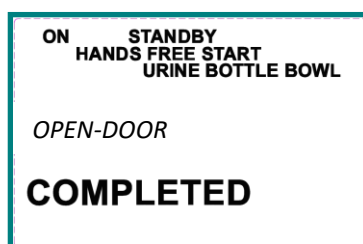

To repeat or run an alternative cycle repeat steps 2, 3, and 4



 When opening door if the temperature in the chamber is above lockout temperature; display will show:

	<b>BEDPAN/URINE BOTTLE</b>	<b>URINE ONLY OR BOWL</b>
<p><b>COOLING WAITING</b></p> <p>Then</p> <p><b>OPEN DOOR</b></p>	<p>ON      <b>STANDBY</b>                  HANDS FREE START                  BEDPAN &amp; URINE BOTTLE</p> <p>COOLING-WAITING</p> <p><b>COMPLETED</b></p>	<p>ON      <b>STANDBY</b>                  HANDS FREE START                  URINE BOTTLE BOWL</p> <p>COOLING-WAITING</p> <p><b>COMPLETED</b></p>

To close door without running cycle

After the door is opened; display shows:

<p><b>LOAD ITEMS</b></p> <p>Then</p> <p><b>SELECT CYCLE</b></p>	<p>ON</p> <p></p>
---	--

- Manually press DOOR button
- Software will check that racks are in correct position before door closes. If racks have been moved, 'WRONG RACK' will flash. Place rack or racks into correct position for any of the 3 cycles and press DOOR button
- Door will close and go to standby

If racks are incorrectly positioned; display shows:

<p><b>WRONG RACK</b></p>	<p>ON</p> <p>WRONG-RACK</p>
------------------------------	-----------------------------

If racks are in correct positions; display shows:

<p><b>CLOSING</b></p>	<p>ON</p> <p>CLOSING</p>
-----------------------	--------------------------

After door is closed without running a cycle; display shows:

<p><b>OPEN DOOR</b></p>	<p>ON      <b>STANDBY</b>                  HANDS FREE START</p> <p>OPEN-DOOR</p>
-----------------------------	--

## 4.1 Release of Processed items

On completion of the cycle, it is recommended that all processed items are unloaded and visually inspected as clean as per the requirements AS 5369. It is recommended all items are removed on completion of the cycle and stored in a designated area to prevent any risk of contamination or mixing with unprocessed items.



If the processing status of a load or item is unknown or in question, it should be treated as unprocessed and not released.

## 5.0 Maintenance



**All maintenance, preventative or breakdown shall be carried out by a qualified person. Failure to comply with this condition may result in unsafe conditions.**

**Preventative maintenance must be completed as per instructions below. Failure to comply may result in warranty claims being rejected.**

The Malmet Bedpan/Urinal Bottle and Utensil/Bowl Washer Disinfector is self-cleaning; however proper care should be taken to ensure that the device is cleaned and maintained in accordance with maintenance instructions for Malmet Bedpan/Urinal Bottle and Utensil/Bowl Washer Disinfector, regulatory requirements and common-sense practices.

### *Preventative Maintenance Schedule*

#### 5.1 Daily Maintenance (Operator or Maintenance Technician)

- a) Run the Bedpan urine cycle to bring the device to operating temperature and disinfect the internal wash chamber area (do not load any items).
- b) Wipe out the inside of the door and gasket with warm water and detergent. A wipe with disinfectant is also desirable.
- c) Wipe over external stainless-steel panels with a stainless-steel cleaner (do not get cleaner into the opening of the USB port).
- d) Wipe the front control panel with a soft cloth and mild detergent as necessary. Care should be taken not to damage the digital display or to activate a cycle (turn off power at control panel).
- e) Check level in detergent bottle, replenish as necessary.
- f) Visually inspect for signs of leaking fluid from the device, as these may pose a pathogenic risk. Inspect around the chamber door, beneath the device and service connection points. If a spill or leak is observed, clean up as per the facility's infection control procedure and notify a maintenance technician to fix the cause of the leak.

#### 5.2 Bi-Monthly Maintenance (Maintenance Technician)



**WARNING 240/415 VOLTS!**

**ISOLATE DEVICE FROM ELECTRICAL SUPPLY BEFORE SERVICING**



**HOT SURFACES!**

**ALLOW DEVICE TO COOL PRIOR TO COMMENCING SERVICE WORKS**

- a) Inspect for steam or fluid leaks, tighten unions, hose clamps and glands where necessary.
- b) Check flush nozzles for free rotation.
- c) Check spray nozzles are not blocked, insert a small pin into the orifice of the spray nozzle to ensure no blockages are present. If a build-up or blockage is detected have technician clean nozzles as per nozzle cleaning instructions below to ensure adequate performance.
- d) Remove level probe in steam generator tank and water tank, clean off any residue build up.
- e) Remove temperature probes in steam generator and chamber and clean off any residue build up.
- f) Visually inspect build-up of residue in steam tank, especially in locations with poor water quality.

- g) Check filter in the water inlet solenoid valve and clean as necessary.
- h) Check all electrical connections, and tighten if necessary.

### **Nozzle Cleaning Instructions**

Remove and clean the sprays in sequence (do not mix sprays with other spray groups).

Chamber top to bottom: Cool down sprays x 2, Top sprays x 4, Bottom sprays x 4, Pan Tip sprays x 2 and rotary nozzles x 2.

Door: Urine bottle sprays x 4 – check that the holes are clear and clean as necessary.

Hold under tap and pressurise through the nozzle outlet in opposite direction of normal flow or clean in ultrasonic cleaner if available. An appropriately sized Oxy-Acetylene tip cleaner pin may be used to clean out spray nozzle orifices. In areas with hard water or high minerals in water supply, chemical de-scaler may be the quickest and easiest means to remove build-up of deposits. Replace before removing next spray group.

### **Stainless Steel Maintenance/Care**

Under normal usage, stainless steel products require regular cleaning with a soft clean rag moistened with a mild detergent followed by a water-moistened clean rag and then a dry rag.

The #4 satin finish steel should be protected against Muriatic acid and caustic or abrasive materials and harsh cleaning detergents. In the event such agents cause discoloration, polish with a stainless-steel cleaner such as 3M Stainless Steel Cleaner & Polish and a pad.

### **5.3 Recommended Preventative Maintenance Schedule (to be performed by qualified maintenance personnel)**

It is recommended that preventive maintenance is performed by a qualified maintenance technician every **3 Months** for devices in high use, **6 Months** for medium use or **Annually** for low use devices



**WARNING 240/415 VOLTS!**

**ISOLATE DEVICE FROM ELECTRIC SUPPLY BEFORE SERVICING**



**HOT SURFACES!**

**ALLOW DEVICE TO COOL PRIOR TO COMMENCING SERVICE WORKS**

1. Remove top and side panels and front bottom panel behind detergent door.

Note: Panel removal

- i) Remove 4 screws on the top panel
- ii) Lift the side panel up to remove
- iii) Remove 2 screws from bottom front panel

2. Remove and clean the sprays as per nozzle cleaning instructions on page 27.

3. Check condition of rack positioning magnets.

Note: Replace magnets annually

4. Check hinge screws for tightness on pan rack and bowl rack.
5. Check condition of door gasket.
6. Steam generator: Check for scale build up inside element housing and water tank. Remove and clean temperature probe and water level sensors.
7. Water Tank: Check for scale build up inside tank and on element. Remove and clean temperature probe and water level sensor.

8. Remove and clean temperature probe at steam outlet.
9. Water inlet solenoids: Check filters for material build up, clean if necessary.
10. Make sure the water fill solenoids are completely shutting off and levels are not creeping up, if so, clean and/or replace the solenoid.
11. Detergent pump: Check hose on pump and hoses in detergent lines for cracks or signs of leaks.
12. Load Cell detergent bottle: Remove detergent bottle, unscrew load cell mounting plate. Ensure that the wire to the load cell is not strained when inspecting the load cell. Clean any detergent residue from under plate. Check load cell for corrosion, lightly spray with WD40.
13. Before replacing panels run purge reset cycle (see 5.18) three times to clear any airlocks in spray lines and check for leaks. Dust down components if necessary. Replace all panels and screws.
14. Cycle verification: Run the 3 cycle options starting with Bedpan/Urinal bottles. Download logged data to PC; and print a report of the last 3 cycles. Check temperatures attained and wash cycle times are within the operating parameters.
15. Replace battery on processor PCB every 12 months. Check time and date are correct, adjust if required.

Malmét will make available on request circuit diagrams, component parts lists, descriptions, calibration instructions, or information which will assist the user's appropriately qualified technical personnel to repair those parts of the device.

#### **5.4 Post Maintenance or Repair Safety Checks**

After service or repair; the device shall be checked to confirm correct cycle operation and that the device is in a safe operating state before being returned to service.

#### **5.5 Door Safety Test**

To check the correct functionality of the door safety and position sensors, open and close the door using the manual door open button. During operation the device will conduct a self-check for correct operation of these switches. Once complete, check door is firmly closed and is flush with outer panel and no faults are displayed.

#### **5.6 Cycle Operation Check**

After completion of the required checks above, a cycle operation check is to be completed. Run the device through a complete cycle ensuring correct sequence of operation as per 4.0 Cycle of Operation. Inspect for fluid leaks from around the chamber door, rear service connections and beneath the device. If no faults are found during the inspection, and the device displays no faults at end of the cycle, the device is fit for return to operation.

#### **5.7 Post Maintenance and Repair of Electrical Systems**

Additional to the above safety tests if any repair or service work has been carried out that could affect the electrical safety of the device; it must be inspected and tested as per the requirements of AS/NZS 3760 prior to being returned to service.

**Information on replacement of these devices can be found in the Service Technicians Manual.**

**If device fails any of the above tests it is not safe for operation, and cannot be put into service until the cause of the fault has been rectified and successful completion of tests.**

#### **5.8 Replacement of Safety Devices**

The following safety devices must be replaced and tested by a Malmét trained technician, failure to do so may impair the protection by the device.

- Door Actuator
- Door Micro Switch
- Water Tank Element Thermal Cut-out
- Steam Generator Thermal Cut-out

Information on replacement of these devices can be found in the Service Technicians Manual.



## **5.9 Validation**

It is recommended that Validation of the device is carried out in accordance with the requirements of AS 5369 & ISO 15883, consisting of 3 identified stages.

IQ – Installation Qualification

OQ – Operational Qualification

PQ – Performance Qualification

### **Installation Qualification**

Performed upon installation of equipment to ensure equipment has been installed in accordance with applicable Standards and manufacturer's instructions.

### **Operation Qualification**

Performed immediately after installation, relocation, change of a service to the device or after repair prior to device being put back in service in accordance with applicable Standards.

### **Performance Qualification**

Performed immediately after IQ or OQ for new installs or relocated equipment, or change of a service to the device or repair that might adversely impact the quality of the RMD.

## **5.10 Requalification**

It is recommended requalification of the process is performed annually in accordance with the requirements of AS 5369 and ISO 15883 applicable parts.

### 5.11 Device faults

In the event of a fault or malfunction with the device during operation, abort the cycle by pressing the Power  On/Off button on the control LCD. Once the device is off, isolate the mains power supply and both the hot & cold-water services. Notify maintenance or service provider of the fault and ensure device is not used until the fault is rectified.

### 5.12 Fault Indication

The operation of the WDS is controlled by a micro-processor. The processor has fault detection capability and indicates faults by code on the LCD display as well as an audible buzzer.

In the event of a failure during cycle the device will go into fault. The display will show the selected cycle the device was operating in when the failure occurred along with a fault code corresponding to the cause of the fault. Access to the load will not be allowed until the cause of the fault has been fixed and a cycle has been successfully completed. Please refer to the Fault Codes section of this manual for a description of the fault code displayed.

**FLT XXX flashing**  
Audible Buzzer will beep

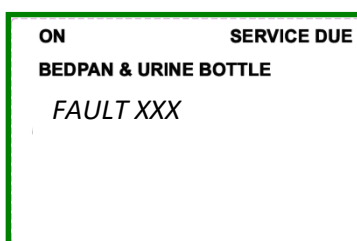

After fault has been rectified a Purge/Reset will be required to reset the device (see 5.16). On completion of the “Purge Reset” device will restart previous cycle and will not allow access to the load until cycle has been successfully completed.

### 5.13 Fault Codes

FAULT CODE	STATE	DESCRIPTION	POSSIBLE CAUSES
901	System	Blockage	P or S trap blockage to drain
902	System	Door open during wash cycle	Faulty door micro-switch J11, J10, actuator, transformer fuse
903	System	Internal system communications error	Display unplugged, LINK J34 removed, loose processor PCB
904	System	Power interrupted during cycle	Mains power supply interrupted
905	System	Power button cycle aborted	Wash cycle aborted prior to completion
906	System	Blockage during purge reset	P or S trap blockage to drain
907/908	System	Steam generator temp sensor fault	Open/Closed Circuit
909/910	System	Tank water temp sensor fault	Open/Closed Circuit
911/912	System	Chamber temp sensor fault	Open/Closed Circuit
913/914	System	Chamber validation temp sensor fault	Open/Closed Circuit
915	System	Disinfection validation timer error	Processor Fault or Real Time Clock Error
101	Power On	Water fill timeout - Water tank and steam generator	Water level sensor failed or water supply low flow or turned off, water fill solenoids failed
102	Power On	Steam fill timeout	Steam fill solenoid failed, steam level sensor failed, blocked inlet hose
120	Power On	Blockage at power on	P or S Trap blockage to drain. Faulty sensor
141	Open Door	Door overcurrent trip	Door is obstructed, actuator motor faulty, door hinges seized
143	Open Door	Door timeout	Actuator motor faulty, blown transformer fuse, door hinges seized
145	Open Door	Chamber Temp Door Interlock	Chamber Temp above safe opening limit, faulty temperature probe, element stuck on.
149	Open Door	Door interlock switches fault	Door interlock switch J11 stuck on when door opens
181	Close Door	Door overcurrent trip	Door is obstructed, actuator motor faulty, door hinges seized





FAULT CODE	STATE	DESCRIPTION	POSSIBLE CAUSES
183	Close Door	Door timeout	Actuator motor faulty, blown transformer fuse, door hinges seized
185	Close Door	Chamber Temp Door Interlock	Chamber Temp above safe opening limit, faulty temperature probe, element stuck on.
186	Door Operation	Door Overcurrent Trip	Door Obstructed or Actuator Motor Fault
188	Door Operation	Door Timeout	Faulty Door Actuator or Micro Switch
190	Door Operation	Chamber Temp Door Interlock	Chamber Temp above safe opening limit, faulty temperature probe, element stuck on.
220	Cold Flush Fill	Water level sensor fail	Dirty conductivity sensor probe, faulty connections, faulty conductivity module
221	Cold Flush Fill	Water fill timeout	Water level sensor failed or water supply low flow, water fill solenoid failed, water supply off
241	Cold Flush Run	Low water level during wash	Check cycle time, pump rate too high, water Leakage
242	Cold Flush Run	Door open	Door opened during wash cycle, faulty door interlock switch J11 J10
243	Cold Flush Run	Pump run without solenoid	Check cycle times parameters, faulty solenoids
244	Cold Flush Run	Timeout before level reached	Low pump water flow, blocked rotary nozzles, faulty 1" solenoid, panel lockout switches J8 open circuit. Faulty level probe. Door interlock switch J11 J10
260	Cold Wash Fill	Water level sensor fail	Dirty conductivity sensor probe, faulty connections, faulty conductivity module
261	Cold Wash Fill	Water fill timeout	Water level sensor failed or water supply low flow, water fill solenoid failed, water supply off
281	Cold Wash Run	Low water level during wash	Faulty 4 -way solenoid, panel lockout switches J8 open circuit. Faulty level probe. Incorrect spray nozzles fitted
282	Cold Wash Run	Door open	Door opened during wash cycle, faulty door interlock switch J11 J10
283	Cold Wash Run	Pump run without solenoid	Check cycle times parameters, faulty solenoids
284	Cold Wash Run	Timeout before level reached	Low pump water flow, blocked spray nozzles, faulty 4 -way solenoid, panel lockout switches J8 open circuit. Faulty level probe. Door interlock switch J11 J10
300	Hot Wash+Det Fill	Water level sensor fail	Dirty conductivity sensor probe, faulty connections, faulty conductivity module
301	Hot Wash+Det Fill	Water fill timeout during detergent	Water level sensor failed or water supply low flow, water fill solenoid failed, water supply off
302	Hot Wash+Det Fill	Detergent timeout	Empty detergent bottle, blocked suction line/tubing, faulty flow sensor, faulty connections, faulty or blocked detergent pump
304	Hot Wash+Det Fill	Water heating timeout	Failed heater element, heater circuit breaker tripped, faulty temp probe. Element over temp cutout tripped, panel lockout switches J8 open circuit. Low water temperature, door interlock switch J11 J10
305	Hot Wash+Det Fill	Water heating low level	Water leakage, faulty wash solenoid, faulty level probe. Faulty connections, faulty conductivity module
321	Hot Wash+Det Run	Low water level during wash	Faulty 4 -way solenoid, panel lockout switches J8 open circuit. Faulty level probe. Incorrect spray nozzles fitted
322	Hot Wash+Det Run	Door open	Door opened during wash cycle, faulty door interlock switch J11 J10



FAULT CODE	STATE	DESCRIPTION	POSSIBLE CAUSES
323	Hot Wash+Det Run	Pump run without solenoid	Check cycle times parameters, faulty solenoids
324	Hot Wash+Det Run	Timeout before level reached	Low pump water flow, blocked spray nozzles, faulty 4 -way solenoid, panel lockout switches J8 open circuit. Faulty level probe. Door interlock switch J11 J10
340	Hot Rinse Fill	Water level sensor fail	Dirty conductivity sensor probe, faulty connections, faulty conductivity module
341	Hot Rinse Fill	Water fill timeout	Water level sensor failed or water supply low flow, water fill solenoid failed, water supply off
344	Hot Rinse Fill	Water heating timeout	Failed heater element, heater circuit breaker tripped, faulty temp probe. Element over temp cutout tripped, panel lockout switches J8 open circuit. Low water temperature, door interlock switch J11 J10
345	Hot Rinse Fill	Water heating low level	Water leakage, faulty wash solenoid, faulty level probe. Faulty connections, faulty conductivity module
361	Hot Rinse Run	Low water level during wash	Faulty 4 -way solenoid, panel lockout switches J8 open circuit. Faulty level probe. Incorrect spray nozzles fitted
362	Hot Rinse Run	Door open	Door opened during wash cycle, faulty door interlock switch J11 J10
363	Hot Rinse Run	Pump run without solenoid	Check cycle times parameters, faulty solenoids
364	Hot Rinse Run	Timeout before level reached	Low pump water flow, blocked spray nozzles, faulty 4 -way solenoid, panel lockout switches J8 open circuit. Faulty level probe, door interlock switch J11 J10
401	Steam Heatup	Steam water level timeout	Water leakage, steam fill solenoid failed, steam level sensor failed, blocked inlet hose
402	Steam Heatup	Steam Water Temp not maintained	Cool Down Spray or Solenoid failure/leak
403	Steam Heatup	Steam Water low level during heatup	Water leakage, steam fill solenoid failed, steam level sensor failed, blocked inlet hose
404	Steam Heatup	Steam water temperature high	Faulty temperature sensor, faulty heater relay, faulty contactors
405	Steam Heatup	Steam timeout	Faulty steam heater element, faulty steam heater relay, heater circuit breaker tripped, over temp switch tripped. Faulty temp probe, faulty contactors. Panel lockout switches J8 open circuit, door interlock switch J11 J10, leaking 4 – way solenoid valve.
421	Steam Disinfect	Disinfect water low level	Water leakage, , steam level probe failed
422	Steam Disinfect	Disinfect water temperature high	Faulty temperature sensor, faulty heater relay, Faulty contactors
423	Steam Disinfect	Disinfect timeout	Faulty steam heater element, faulty steam heater relay, heater circuit breaker tripped, over temp switch tripped. Faulty temp probe chamber steam outlet, faulty contactors. Blocked condenser coil. Blocked mesh on steam outlet, panel lockout switches J8 open circuit, door interlock switch J11 J10
424	Steam Disinfect	Temp Probe Differential	Differential between control and validation temp probes has exceeded tolerance.
425	Steam Disinfect	Disinfection	Difference between Control and Monitoring timebase > 3 second





FAULT CODE	STATE	DESCRIPTION	POSSIBLE CAUSES
801	Purge flush	Low water level during wash	Low pump water flow, blocked spray nozzles, faulty solenoid, panel lockout switches J8 open circuit. Faulty level probe. Incorrect spray nozzles fitted
802	Purge flush	Door open	Door opened when attempting pure rest, faulty door interlock switch J11 J10
803	Purge flush	Pump run without solenoid	Check cycle times parameters, faulty solenoids
804	Purge flush	Timeout before level reached	Low pump water flow, blocked spray nozzles, faulty solenoid, panel lockout switches J8 open circuit. Faulty level probe. Door interlock switch J11 J10
805	Purge Cold Fill	Water level sensor fail	Dirty conductivity sensor probe, faulty connections, faulty conductivity module
806	Purge Cold Fill	Water fill timeout	Water level sensor failed or water supply low flow, water fill solenoid failed, water supply off

### 5.15 Making equipment safe after incomplete operating cycle

If an incomplete cycle has occurred, it is assumed that the load being processed has not been subjected to a complete cycle as per the set process parameters. For this reason, access to the load is restricted and will not be allowed until a full cycle has been completed. At the end of an incomplete cycle or on powering up the device after an incomplete cycle, a fault code will display relating to the cause of the incomplete cycle (Please see section 5.13 Fault Codes for description of fault code). Depending on the nature of the fault a purge reset option may be available; this can be done by following the instructions as per section 5.16 of this manual. If the device does not allow a purge reset to be completed, or the fault re-occurs after a purge reset, it is recommended that the device is isolated and service is arranged to correct the fault.



### 5.16 Purge Reset (Operator)

1. Turn power OFF  at control LCD display
2. Turn power ON  at control LCD display
3. The display will alternate between the current fault/s and “PURGE”, press SELECT  to start the Purge Reset cycle

When purge is complete the previous cycle will automatically start to ensure the load is disinfected, access to the load is restricted until a cycle has been completed to the required parameters

If the fault reoccurs contact maintenance or service provider

### 5.17 Purge Detergent Line (Operator)

1. Turn power OFF  at control LCD display
2. Turn power ON  at control LCD display

On powering back on the display will show TEST 302

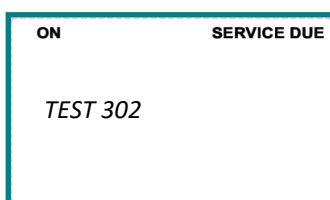









3. The detergent line will automatically purge if necessary for a predetermined time or until the detergent is detected
4. Once detergent is detected the fault will clear and the previous cycle will be restarted

If the detergent fault is not cleared check detergent level and repeat the purge process again, if the detergent fault continues and is unable to be cleared contact maintenance or service provider

**The following functions must only be undertaken by Malmet service personnel or Malmet-trained facility maintenance personnel.**

### 5.18 Manual Purge Reset (Maintenance)

1. Turn power OFF  at control LCD display
2. Turn power ON  at control LCD display
3. Hold down both SCROLL  and SELECT  buttons, when MENU is displayed, release buttons
4. SCROLL  to SERVICE menu and press SELECT 
5. SCROLL  to RESET menu and press SELECT  'CONFIRM' should then display
6. Press SELECT  again to start Purge Reset cycle

When purge reset is completed the display will resume normal operation













### 5.19 Manual Purge Detergent Line (Maintenance)

1. Turn power OFF  at control LCD display
2. Turn power ON  at control LCD display
3. Hold down both SCROLL  and SELECT  buttons, when MENU is displayed, release buttons
4. SCROLL  to TEST menu and press SELECT  RELAY
5. SCROLL  to DETERG menu and press SELECT  START press SELECT  START/RUNNING

The detergent pump will run for 5 seconds, if detergent line completely purged display shows PASS; then DETERG

If display shows FAIL, check detergent level and repeat Purging of the Detergent Line







## 5.20 Safe Access to the Load or Chamber in Fault Condition

1. Turn power OFF  at control LCD display
2. Turn power ON  at control LCD display
3. Hold down both SCROLL  and SELECT  buttons, when MENU is displayed, release buttons
4. SCROLL  to TEST menu and press SELECT  RELAY
5. SCROLL  to DOOR OPEN and press SELECT  to turn on the door opening relay (ensure hands are clear and no obstructs or objects are in the opening path of the door)
6. Once the door is open, press SELECT  to turn off the door open relay
7. To close the door, press SCROLL  to DOOR CLOSE and SELECT  to turn on the door closing relay (ensure hands are clear and no obstructs or objects are in the opening path of the door)
6. Once the door is closed, press SELECT  to turn off the DOOR CLOSE relay



**Treat all items in the load/chamber as unprocessed, do not use until they can be cleaned or processed accordingly.**

### To EXIT Service Menu:

1. SCROLL  to EXIT press SELECT 
2. SCROLL  to EXIT press SELECT 
3. SCROLL  to EXIT press SELECT 

**Once all menus have been exited the LCD screen will turn blank, once unit is powered on from this state it will return to normal operation.**



## 6.0 Technical Data

### 6.1 Power and Water Consumption

Power and Water Consumption Data (for all WDS 1ph models)						
Type of Cycle	Disinfecting Time/ Temp	Avg Cycles per/Hr	Avg Cycle min/sec	Avg kWh	CW Avg Lt Per cycle	HW Avg Lt per cycle
Bedpan / Urinal Bottle	1 min @ 90°C	4.7	12.45	0.62	35.6	21.6
Urinal Bottle Only	1 min @ 90°C	5.3	11.15	0.572	24.4	20.7
Bowl / Utensils	1 min @ 90°C	5.2	11.30	0.572	24.4	20.7

Power and Water Consumption Data (for all WDS 3ph models)						
Type of Cycle	Disinfecting Time/ Temp	Avg Cycles per/Hr	Avg Cycle min/sec	Avg kWh	CW Avg Lt Per cycle	HW Avg Lt per cycle
Bedpan / Urinal Bottle	1 min @ 90°C	5.1	11.45	0.60	35.6	21.6
Urinal Bottle Only	1 min @ 90°C	5.8	10.15	0.574	24.4	20.7
Bowl / Utensils	1 min @ 90°C	5.7	10.30	0.574	24.4	20.7



NOTE: Values may change due to operating and supply service conditions



## 6.2 Device Specifications

Model WDS Single Phase	Electrical Rating	Volts	240V	APPROVALS
		Phase / Hz	1 ph / 50 Hz	
		Amps	20 Amps	
	Heating Elements	Steam Generator	4500W 240V 3 x 6.25A Star	
Water tank		4500W 240V 3 x 6.25A Star		
Model WDS Three Phase	Electrical Rating	Volts	415V	
		Phase / Hz	3 ph / 50 Hz	
		Amps	20 Amps	
	Heating Elements	Steam Generator	4500W 240V 3 x 6.25A Star	
		Water tank	7200W 240V 3 x 10A Star	
	Heating Element Contactors	Steam heating element	3 pole 7.5kw	
W/Tank heating element		3 pole 7.5kw		
<b>ELECTRICAL (Common components)</b>				
Element over temperature cut-out	Steam Generator	Capillary bulb thermal cut out Manual reset 115°C 25A		
	Water tank	Capillary bulb thermal cut out Manual reset 100°C 25A		
Fuse: Transformer	Cylinder type 5 x 20mm	T 5A H 250Vac Time Delay		
Door Actuator	Type LA12 Self-Locking	24VDC		
Interlock Micro Switch	SPDT	240VAC 16A		
Processor module battery	Coin Cell	CR2032 Lithium 3Volts		
<b>PCB HARDWARE</b>				
PCB (Printed Circuit Boards)	Display LCD	D134411		
	Heating switch module	D132213		
	Control module	D134412		
	Processor module	D133447		
	Conductivity sensor	D134418		
PC Interface Port	USB Type B			
Environment conditions (Operating)	Location	Indoor Use		
	Altitude	<2000m		
	Temperature	+10°C to +25°C		
	Relative Humidity	+30% to 75%		
	Mains voltage fluctuations	240±10%		
	Overvoltage	Category II		
	Pollution	Degree II		
<b>WASH CHAMBER</b>				
Loading Configurations	Bedpan Cycle	4 x Urinal Bottles and <u>One (1)</u> of the following:		
		2 x Small slipper pans & Lid		
		2 x Large Slipper pans & Lid		
		2 x Standard Bedpans & Lid		
	Urinal Cycle	4 x Urinal bottles Only		
	Bowl / Utensil Cycle	2 x Large bowls		
		3 x Medium bowls		
6 x Large kidney dishes				
6 x Medium kidney dishes				
		Assortment of Smaller bowls and kidney dishes using optional accessory basket.		
Chamber Specifications	Material	1.2mm 304 Stainless Steel		
	Design Life	Minimum of 10,000 Cycles		
	Usable Volume	100L		
	Total Volume	115L		
<b>WASH SYSTEM</b>				
Nozzles and Sprays	Flush nozzles	2 x Rotary Nylon		
	Tip sprays	2 x WL1/2 120° 1/8 BSP SS		
	Top sprays	4 x WL1/4 90° 1/8 BSP SS		
	Bottom sprays	4 x WL1/2 60° 1/8 BSP SS		



	Urine Bottle sprays	4 x WL1/4 90° 1/8 BSP SS		
	Cool Down sprays	2 x LW1 120° 1/4 BSP SS		
<b>Wash pump</b>	Horizontal multistage	240V 1ph 3.1A		
<b>Detergent</b>	Malmet specific (5Lt)	Detergent Concentrate Caustic Alkaline	ARTG Class 1	
<b>Detergent pump</b>	Self-priming peristaltic pump	240V 50Hz		
<b>PLUMBING</b>				
<b>Soil line Connection</b>	Type	'S' or 'P' Trap (6mm PE) 80°	Complies to AS 2887-1993 (R2017) AS/NZS 3500.1:2018 & AS/NZS 3500.2:2018	
	Size	100mm ID		
<b>Backflow Prevention</b>	Air Gap (RAG)	Water storage tank	AS 2845.2 - 2010	
<b>Cold water inlet Supply Potable Water (Final Rinse Water)</b>	pH	6.5-8.5pH		
	Chloride	<30mg/L		
	Water Hardness	<2.5mmol/L		
	Water conductivity	<850 µS/cm		
	Temperature	15 – 25°C		
	Pressure	100 – 350kpa		
	Nominal Flow Rate	10L/Min		
<b>Hot Water inlet supply</b>	Solenoid Valve 1 in 2 out	240V - GB¾ male	WRAS Certified	
<b>Hose – valve to Water Tank</b>	Temperature	55 – 60°C		
	Pressure	100 – 350kpa		
	Nominal Flow Rate	10L/Min		
	Solenoid Valve 1 in 1 out	240V - GB¾ male	WRAS Certified	
<b>Hose – valve to Water Tank</b>	S/Steel Braided	10mm	WRAS Certified	
<b>Hoses – Mains Water Supply to Inlet Valve</b>	S/Steel Braided	G¾ Hex Nut Each End 1.5M x 10mm	Certified to AS/NZS 3499-2006 (R2016)	
<b>CONSTRUCTION MATERIALS</b>				
<b>Materials</b>	Frame	25 x 25 x 1.6 tube SS		
	Wash chamber	304 SS grade 4		
	Door	304 SS grade 4		
	External panels	304 SS grade 4		
	Water tank	316 SS grade 2B		
	Steam generator	316 SS grade 2B		
	Fasteners	304/316 SS		
	Thermal insulation chamber and water tank	10mm Cello HR 290 VLC HT		
<b>Principal Heavy Component</b>	Main Wash Pump	11kg		
<b>TRANSPORTATION</b>				
<b>HANDLING &amp; STORAGE CONDITIONS</b>	 Fragile	 Keep away from rain	 Do not stack	
	Temperature	-5°C to +50°C		
<b>DIMENSIONS &amp; WEIGHTS</b>				
<b>Weights</b>	Nett:	Operating:	Shipping:	Shipping (crated):
	140kg	176kg	165kg	217kg
<b>Dimensions (H x W x D)</b>	1695X610 x 625		1870 x 810 x 800	1910 x 810 x 800
<b>Floor Loading at Each Support as viewed from front of unit. * Loadings are a guide only &amp; will vary between installations.</b>	Front Left	Front Right	Rear Left	Rear Right
	58kg*	44kg*	49kg*	25kg*



6.3 Wiring Diagram (1ph devices) Manufactured after June 2020

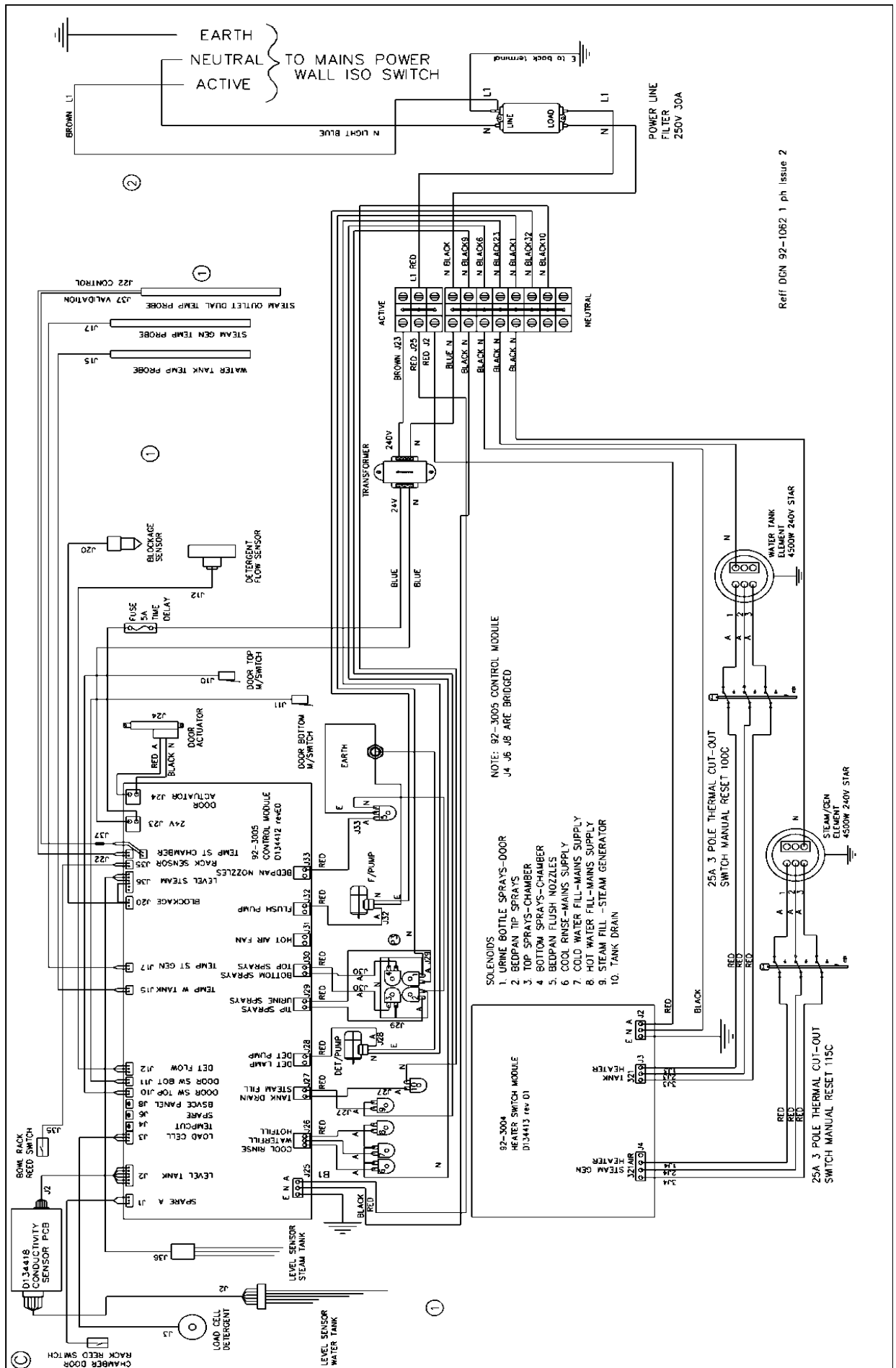

Reff DGN 92-1062.1 ph issue 2

### 6.3 Wiring Diagram (1ph devices) Manufactured before June 2020

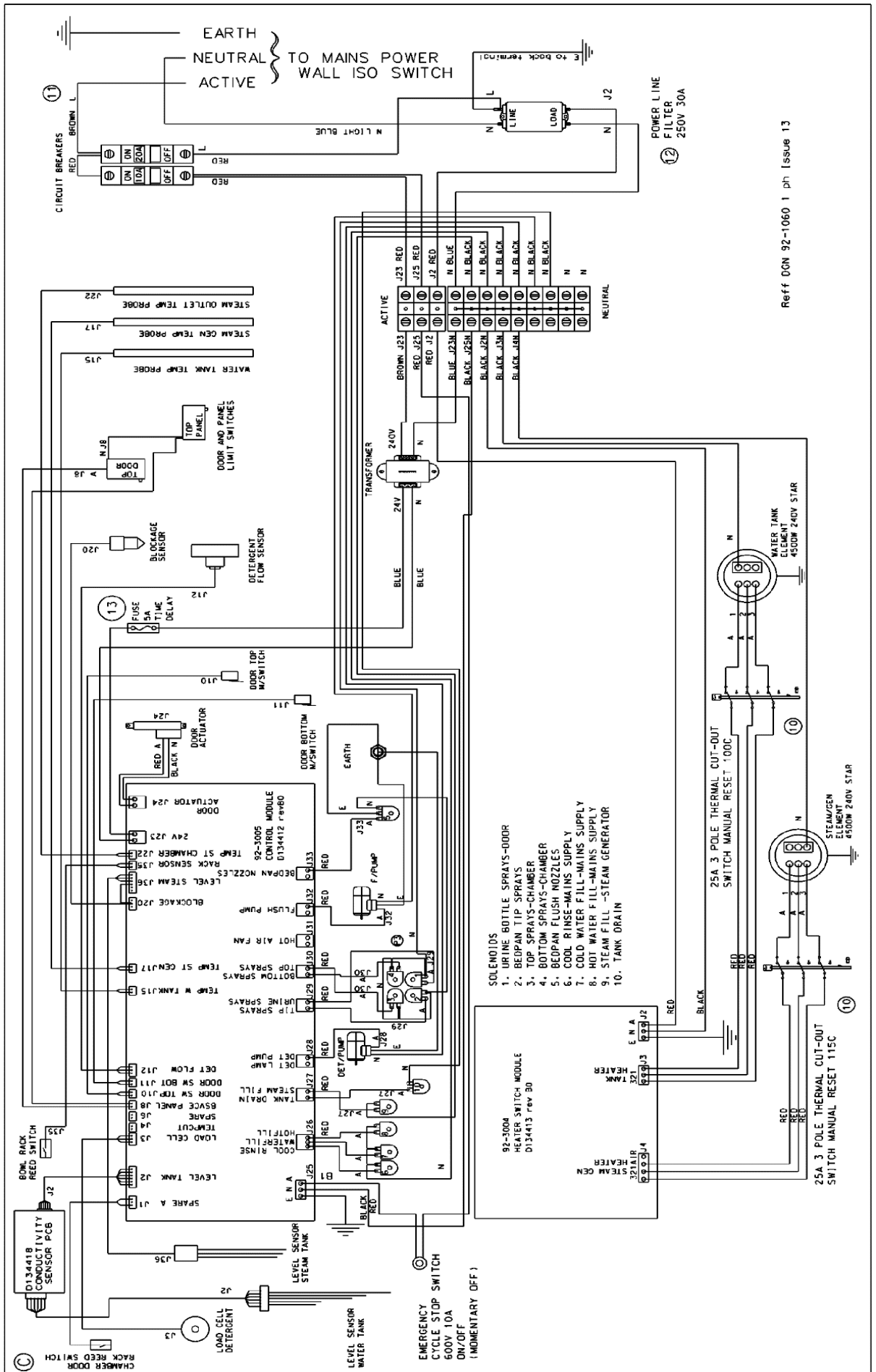

Reff DON 92-1060 1 ph Issue 13



6.4 Wiring Diagram (3ph devices) Manufactured after June 2020

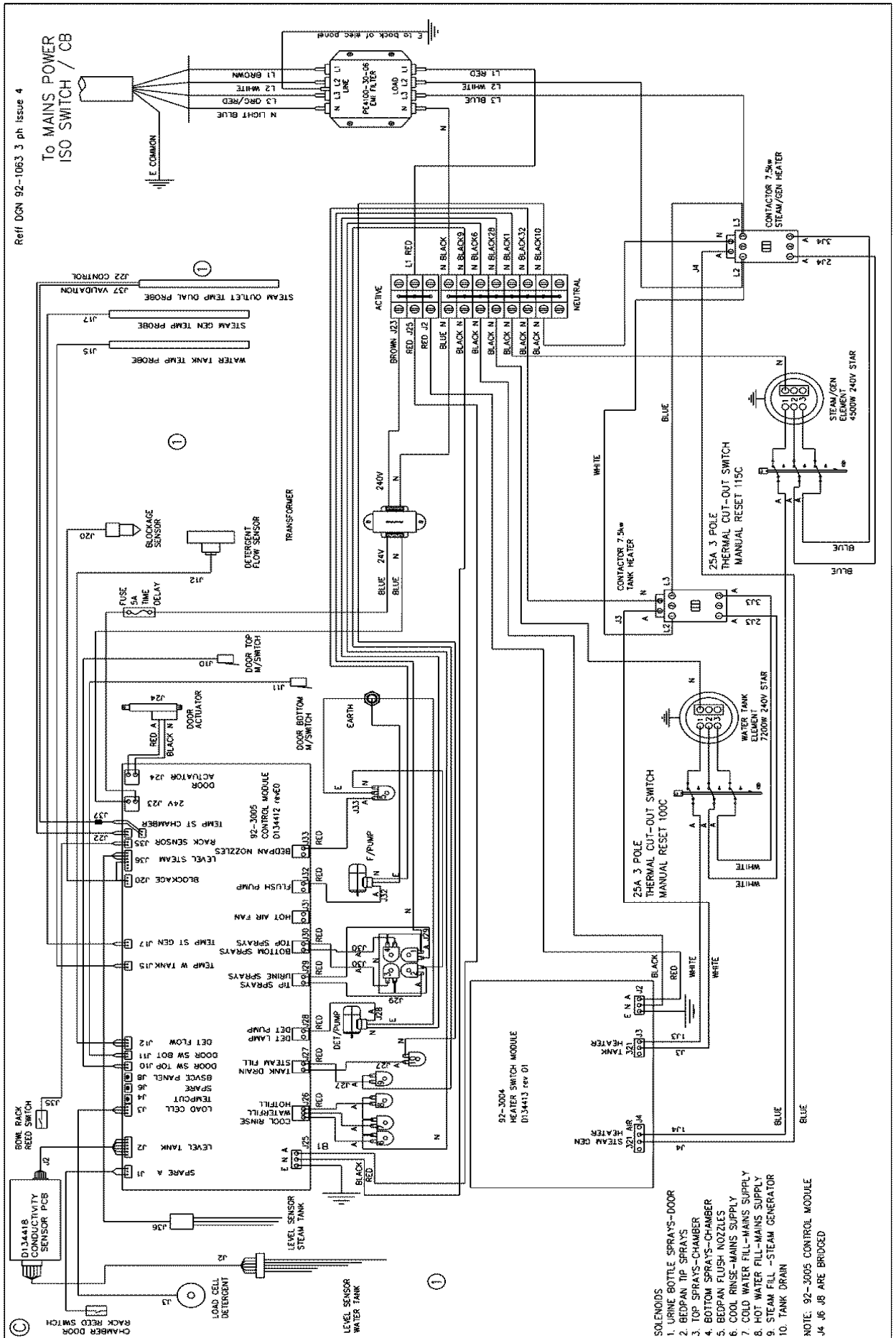

### 6.4 Wiring Diagram (3ph devices) Manufactured before June 2020

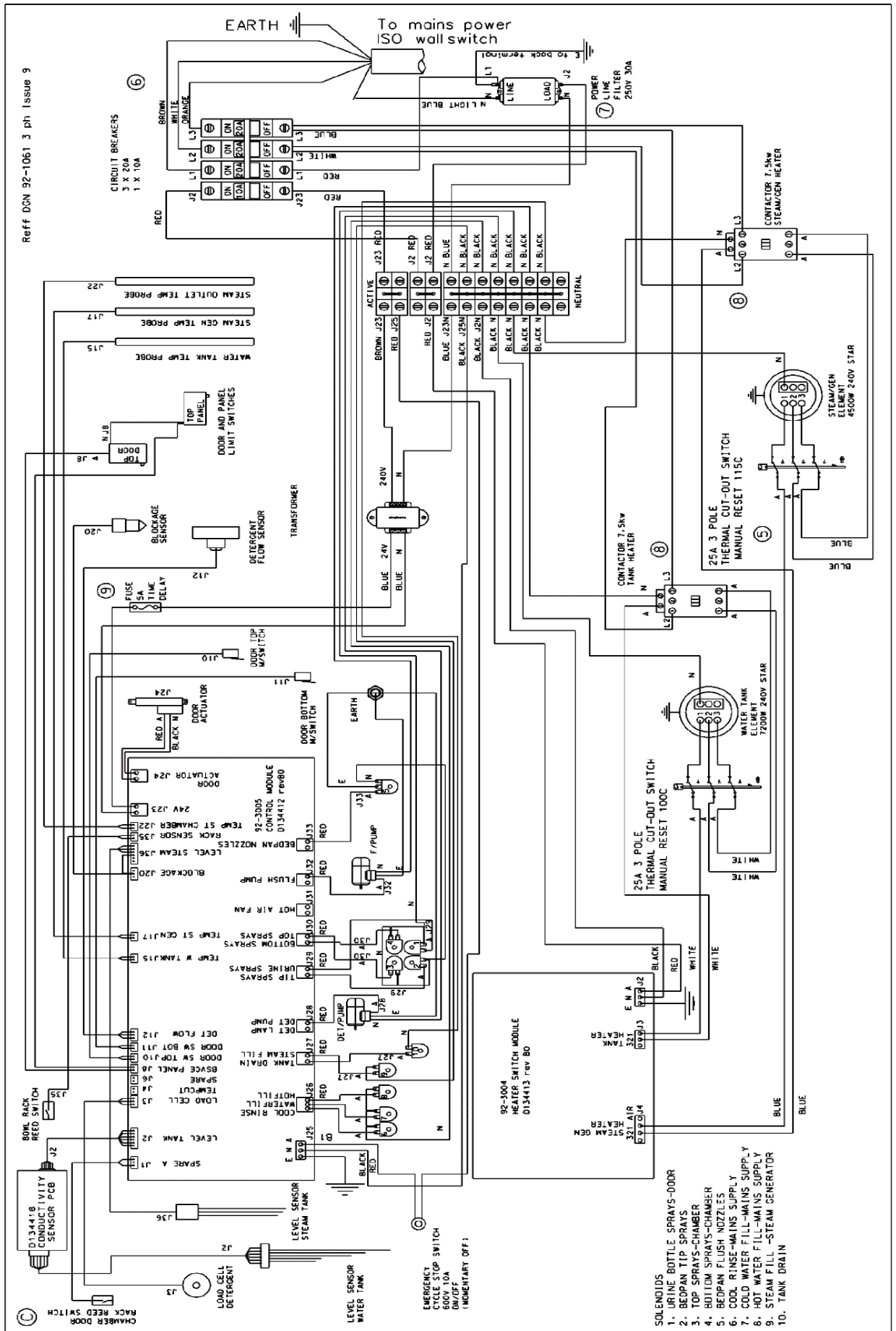



## Warranty Statement

This warranty is provided, and operates in addition to, the statutory warranties Malmet (Australia) Pty Ltd ("Malmet") provides to any consumer under the Australian Consumer Law (if applicable) or by virtue of any other applicable legislation.

Subject to the following conditions, we provide, from the date of purchase, the following warranty on Malmet devices and spare parts for products manufactured by Malmet and sold in Australia:

- Functional components found within the device to be defective in workmanship or material will be repaired or replaced free of charge subject to the periods of warranty specified in the table below.
- A decision regarding whether the defective components will be repaired or replaced will be determined at the sole discretion of Malmet or its authorised agents or representatives.
- The structural warranty covers any structural components within the device, which fail to perform their intended function due to faulty manufacture or deterioration within the warranty period.
- Parts replaced in devices under warranty are warranted for the balance of the original warranty period for that device.

Malmet Devices	
Device Components	Parts & Labour
Structural Guarantee	2 Years from Date of Purchase
All other components	2 Years from Date of Purchase

Malmet Spare Parts
1 Year from Date of Purchase

The installer is responsible for the correct installation, start up and demonstrating the operation of the product. They are also responsible for issuing the relevant certificates of compliance (these may differ from state to state).

### CONDITIONS AND EXCLUSIONS

- Device must be installed and commissioned according to Malmet’s instructions (outlined in Malmet Operation, Maintenance and Installation Manual) and operated to the purpose it was designed.
- Device must be serviced as instructed in the Operation, Maintenance and Installation Manuals.
- To the extent permitted by law, this warranty shall not cover damage, malfunction or failure resulting from accident, misuse or misapplication, improper or unauthorised repair, neglect or modification or use of unauthorised replacement parts or accessories, inclusive of detergent, or improper voltage. The warranty may be void if the serial number is removed or altered.
- Parts damaged in transit back to Malmet Leeton due to poor packaging could result in warranty claim being rejected in part or in full.
- Any part tampered with or which has been altered by unauthorised repairs and/or modifications will be rejected under a warranty claim to the extent permitted by law (to the extent the Australian Consumer Law applies, Malmet will assess the extent to which the tampering or unauthorised repairs contributed to the failure).
- Reasonable access must be allowed for maintenance. If any additional equipment is needed to provide access to the device, this must be provided (and paid for) by the owner.
- It is the owner's responsibility to provide safe access to the device. Malmet, or any of its authorised service agents, may refuse to perform maintenance or warranty work if access is unsafe, as determined by Malmet or any of its authorised service agents acting reasonably.
- Should a warranty claim be rejected you will be advised in writing with a full explanation of our reasons.
- Malmet have a Warranty Claim Procedure that is fair to our customers and provides an efficient system of replacement and/or repair of faulty parts. If at any time you believe we are not meeting our commitment to you please contact Malmet Head Office via email: [info@malmet.com.au](mailto:info@malmet.com.au)

- To the extent permitted by law, no responsibility will be accepted for outside elements including, but not limited to storms, pest and vermin that may cause damage to the device.
- To the extent permitted by law, no responsibility will be accepted for damage incurred as a result of, or incidental to, electrical surges or brown outs or for any other consequential damages.
- If there is no certificate of compliance for plumbing or electrical, Malmet reserves the right to refuse service on non-compliant installations.
- To the extent permitted by law, claims for damage to contents, carpet, ceilings, foundations or any other consequential loss either direct or indirect resulting from, power spikes, incorrect operation, incorrect installation, faulty product or any other cause, are excluded.
- This warranty, and to the extent permitted by law, any warranties owed by Malmet under the Australian Consumer Law or other applicable legislation, are not transferrable and cannot be sold, assigned or transferred in any other way from the purchaser to any other person.
- To the extent permitted by law, unauthorised use of any parts that were not supplied or approved for use in the applicable device by Malmet will result in this warranty and any warranty claims applicable to that device being void.
- Warranty labour (service work) shall not include devices located outside of city metropolitan areas of Melbourne, Sydney, Adelaide, Perth and Brisbane. Costs outside these areas shall be borne by the owner. The owner shall be notified of this prior to the warranty call out.
- Warranty labour (service work) shall be performed during normal business hours (Monday – Friday 7am – 4pm), excluding public holidays.
- Warranty labour (service work) performed outside of normal business hours, shall be charged at Malmet’s or its authorised representative or agent’s standard after-hour labour rates.
- Warranty relating to spare parts covers parts only and does not include any associated labour costs.

To the extent permitted by law, a charge will be made for work done or a service call made where:

- There is no fault apparent with the device, as determined by Malmet or its authorised representative or agent acting reasonably.
- The defective operation of the device is due to failure of electricity or water supply.
- Defects are caused by neglect, incorrect application, abuse or by accidental damage of the device.
- An unauthorised person has attempted to repair the device.
- Harsh environmental situations including, but not limited to, water quality that may cause the water tank damage cannot be covered under this warranty



**HOW TO MAKE A CLAIM UNDER THIS WARRANTY**

If you believe there is a defect in a device you have purchased from Malmes, you must notify Malmes in writing of such defect, by sending an email (Notice of Defect) to [info@malmes.com.au](mailto:info@malmes.com.au) prior to the expiration of the applicable warranty period set out in this warranty.

For the avoidance of doubt, Malmes must receive your Notice of Defect prior to the expiration of the warranty period.

To the extent permitted by law, Malmes will not reimburse you for any expense you incur in claiming or attempting to make a claim for repair or replacement of a component under this warranty.

Please complete details below:

Date Purchased:	Warranty Expiry Date:
Sold To:	For Service Contact:

**PROOF OF PURCHASE**

Please retain your proof of purchase (receipt, invoice or commissioning certificate is accepted).

E.&O.E.

In the interest of continued product improvement, Malmes reserves the right to alter specifications without notice.

**AUSTRALIAN CONSUMER LAW DISCLAIMER (APPLIES ONLY TO THE EXTENT YOU ARE A 'CONSUMER' WITHIN THE MEANING OF THE AUSTRALIAN CONSUMER LAW):**

Malmes goods come with guarantees that cannot be excluded under the Australian Consumer Law. You are entitled to a replacement or refund for a major failure and for compensation for any other reasonably foreseeable loss or damage. You are also entitled to have the goods repaired or replaced if the goods fail to be of acceptable quality and the failure does not amount to a major failure.



**Manufactured by**  
Malmet (Australia) Pty Ltd  
**ABN 95 001 717 791**  
[www.malmet.com.au](http://www.malmet.com.au)