Malmet (Australia) Pty Ltd



Head Office & Customer Service

9-11 McKay Avenue

PO Box 373

LEETON NSW 2705

Phone: (02) 6953 7677

Email: inquiries@malmet-aus.com.au

ABN 95 001 717 791

Top Loading Washer Disinfector



Operation, Maintenance and Installation Manual

Serial Number:.....	Supplied to:.....
Date Installed:.....	Installed by:.....

*Note: Due to Malmet's Policy of continuous product improvement;
design and technical specifications are subject to change without notice.*

Table of Contents

<i>Forward</i>	3
<i>Quality Policy</i>	3
<i>Safety Instructions</i>	4
<i>Design Parameters</i>	5
<i>Section A – Unit Operation</i>	6
<i>Unit Loading Diagram</i>	6
<i>Cycle of Operation</i>	7
<i>Section B – Unit Maintenance</i>	9
<i>Preventative Maintenance</i>	9
<i>Printed Circuit Board - Layout Diagram</i>	10
<i>Wiring Diagram</i>	11
<i>Fault Finding Guide</i>	12
<i>Resistance Temperature Chart</i>	15
<i>Section C – Unit Installation</i>	16
<i>Service Connections</i>	16
<i>Electrical</i>	16
<i>Plumbing</i>	17
<i>Service Connection Layout Diagram</i>	18
<i>Unit Specifications</i>	19
<i>Warranty Statement – Australia Only</i>	20



Operation, Maintenance and Installation Manual

Forward

In order to obtain maximum life and efficiency from your Malmet Top Loading Washer Disinfector and to aid in the safe operation of the unit, please read and understand this manual thoroughly and follow all instructions before operating the unit.

This unit is not intended for use by persons (including children) with reduced physical, sensory or mental capabilities, or lack of experience and knowledge, unless they have been given supervision or instruction concerning use of the unit by a person responsible for their safety.

Children should be supervised to ensure that they do not play with the unit.

The specifications supplied in this manual were in effect at the time of publication. However, owing to Malmet (Australia)'s policy of continuous improvement, changes to these specifications may be made at any time without notice on the part of Malmet (Australia).

Certifications

Electrical Safety: **Cert No. CS10083N**
EMC Cert of compliance T130121

Watermark: Cert No. WMKA 21156

Quality Policy

Malmet (Australia) is Quality Certified to ISO 9001, AS 3902, NZS 9002 and guarantees the quality of this product. Should you have any problems with your machine, contact the company from whom you purchased it, or Malmet (Australia).

Malmet (Australia) Pty Ltd

Head Office and Customer service
9-11 McKay Avenue
PO Box 373
LEETON NSW 2705

Telephone: (02) 6953 7677
E-mail: inquiries@malmet-aus.com.au
Web Site: www.malmet.com.au



SAFETY INSTRUCTIONS

WARNINGS



Be aware of 240V Voltage



Disconnect power when servicing



Mains power ISO switch must be in an accessible position so device can be isolated from mains power during service.



Be aware of steam discharge.



Goods and racks are hot to handle



Safety Gloves and Goggles must be worn when changing detergent



Be aware of hot pipes and hoses from Steam and hot water



Install temperature probes and Element over temperature protection thermal cut-outs correctly.



Operation, Maintenance and Installation Manual

Design Parameters

The Top Loading Washer Disinfector has been designed within the following parameters:

- a) Hospital utensils such as wash basins and bowls, kidney dishes, tooth mugs and suction bottles can be washed and disinfected during each fully automatic cycle. The unit is designed to hold six large or small wash bowls, ten mugs and/or four kidney dishes. Alternative racking will allow load variations.
- b) Holding racks are designed to ensure that the force of the water does not dislodge articles.
- c) The chamber and lid are self-cleaning and do not permit water or soil to remain after a properly completed cycle.
- d) The stages of the cycle are:
 - i. Cold water wash
 - ii. Hot water wash with detergent added automatically
 - iii. Hot water rinse
 - iv. Hot water disinfection cycle; and
 - v. Cold water rinse
- e) The hot water wash with detergent is able to be pre-set by factory or service personnel to two, three, four or five minutes.
- f) The disinfection cycle is able to be pre-set by factory or service personnel to any of the following options in accordance with AS/NZS 4187:2003, Section 10, Clause 10.2.1 – Thermal Disinfection.

Note:  Higher temperature settings may affect reusable instruments and equipment placed in the Washer Disinfector for disinfection. Malmet factory setting is at 80°C.

Temperature	Time (min)
90°C	1
80°C	10
75°C	30

In accordance and complies with

Cleaning Efficacy
AS/NZS 4187:2003, ISO 15883-1

Thermal Disinfection
AS/NZS 4187:2003, ISO 15883-1

Note:  A red flashing light system has been incorporated to indicate a fault if a properly executed cycle has not been completed within a pre-set time.

Warning  Disconnect power when servicing



Section A – Unit Operation

Unit Loading Diagram

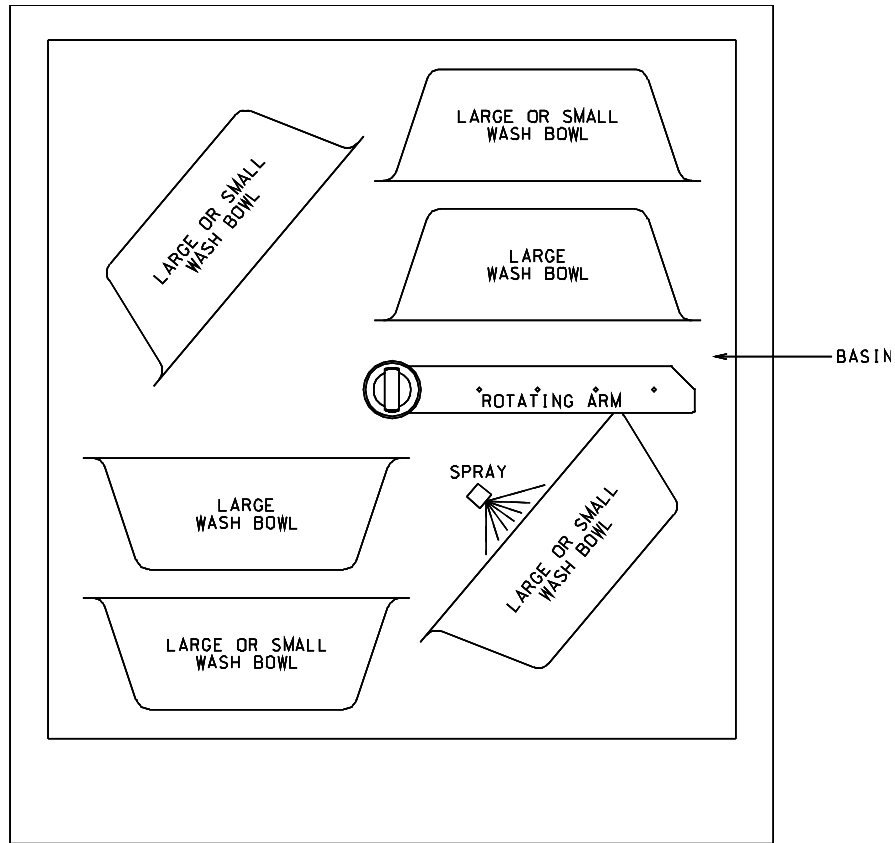

FRONT OF MACHINE

LOADING DIAGRAM – VIEW LOOKING DOWN INTO BASIN

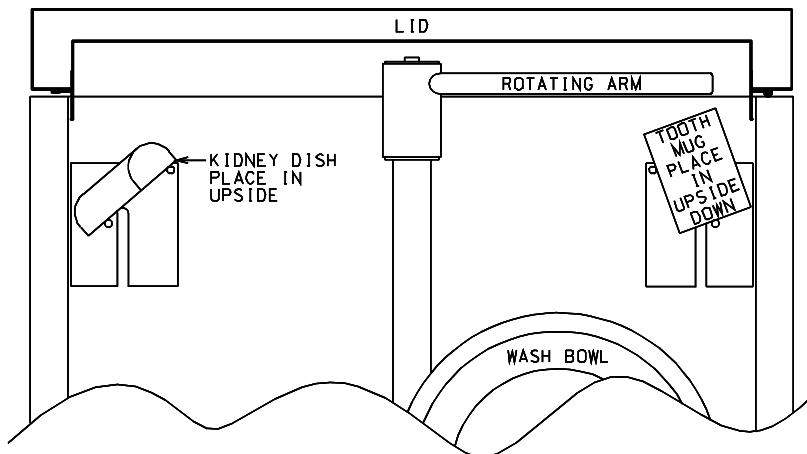

LOADING DIAGRAM – LOOKING FROM FRONT OF MACHINE



Operation, Maintenance and Installation Manual

Cycle of Operation

The automatic operation of the Top Loading Washer Disinfector is as follows:

1. Ensure hot and cold water taps are on.
2. Ensure wall isolation switch is on.
3. Open lid and place all utensils to be washed in the racks provided for them.
4. Close the lid and close the latch.
5. Switch on 'POWER ON' button on front control panel. A white light will illuminate.
6. Push 'CYCLE START' button. The door then locks and the 'IN PROGRESS' light illuminates. The cleaning and disinfection process proceeds as follows:

These times may vary as they are based on minimum incoming hot water supply temperature of 40°C @ 350kpa.

Stage 1 – Pre-Rinse - 4 minutes.

1. Cold water fill
2. Wash
3. Drain

Stage 2 – Wash – 6 minutes.

1. Hot water fill – Temperature 55°C
2. Detergent added
3. Wash (for factory pre-selected time)
4. Drain

Stage 3 – Rinse – 4 minutes.

1. Hot water fill – Temperature 60°C
2. Wash
3. Drain

Stage 4 – Disinfection – Fill/Heating 15 minutes and Disinfection 10 minutes.

1. Hot water fill – Temperature 80°C
2. Washing and Disinfection (heating system will stay on as necessary to complete disinfection/time requirement)
3. Drain

Stage 5 – Post Rinse – 5 minutes.

1. Cold water fill
2. Wash
3. Drain
4. Door Release



Operation, Maintenance and Installation Manual

Cycle of Operation (continued)

'CYCLE COMPLETE' light will illuminate and door may be unlatched and machine then reused.

Note 1: If 'FAULT INDICATED' light illuminates, check the Fault Finding Guide in this manual (refer to page 15-17). Call Malmét for service (02) 6953 7677.

Note 2: If 'FAULT INDICATED' light illuminates, the machine will automatically pump out the water inside the machine, however, the door lock will not release.

Note 3: A typical cycle time for the Washer Disinfector with 60°C hot water input, and approximately 350 kPa water pressure will be 32 minutes. In low pressure installations the cycle time will be longer, however, removal of the flow regulators from the water inlet valves will help alleviate this problem. To remove the regulator, remove filter screens from the water solenoid valves and remove the orifice plate from the water inlet valve entirely and replace the filter screens.

In areas of high water pressure, the water fill tank could overflow. This problem can be fixed by partially turning off the water supply taps or obtaining smaller flow regulators from Malmét.



Section B – Unit Maintenance

Preventative Maintenance

Daily (Operator)

1. Wipe out inside of chamber with warm water and detergent.
2. Wipe over outside panels with stainless steel cleaner.
3. Visually check screen in the bottom of the chamber. Wash clean with hot water if necessary.
4. Check the level of detergent at front viewing panel. If the detergent bottle is empty, replace with full bottle. Remove hose complete with nozzle and bottle lid from empty bottle and place on the new bottle. Detergent is available from Malmét.

Weekly (Operator or Maintenance Technician)

Scale from the water supply may build up on the float level switches which may inhibit their operation. Float level switches should be inspected regularly and wiped clean and if necessary cleaned with a suitable descaling compound i.e. MEDAC

Bi-Monthly (Maintenance Technician)

1. Remove water hose from the water inlet solenoid valves at the rear of the unit and clean filter screens.
2. Check and tighten all hose clamps and visually check hoses.
3. Check and tighten, if necessary, all electrical connections.
4. Clean thermostat probe in the chamber.
5. Check that float level switches are clean and operating freely.
6. Remove and clean out water sprays and rotating spray arms.
Note: Whole spray arm can be removed by releasing the coupling at the bottom of the chamber.
7. Gently clean printed circuit board for dust build up.

Stainless Steel Maintenance/Care

Under normal usage, stainless steel products require regular cleaning with a soft clean rag moistened with a mild detergent followed by a water moistened clean rag and then a dry rag.

The #4 satin finish steel should be protected against Muriatic acid and caustic or abrasive materials and harsh cleaning detergents. In the event such agents cause discoloration, polish with a stainless steel cleaner such as 3M Stainless Steel Cleaner & Polish and 3M Scotch Brite pad.

Malmét will make available on request circuit diagrams, component parts lists, descriptions, calibration instructions, or information which will assist the user's appropriately qualified technical personnel to repair those parts of the product.



Operation, Maintenance and Installation Manual

Printed Circuit Board - Layout Diagram

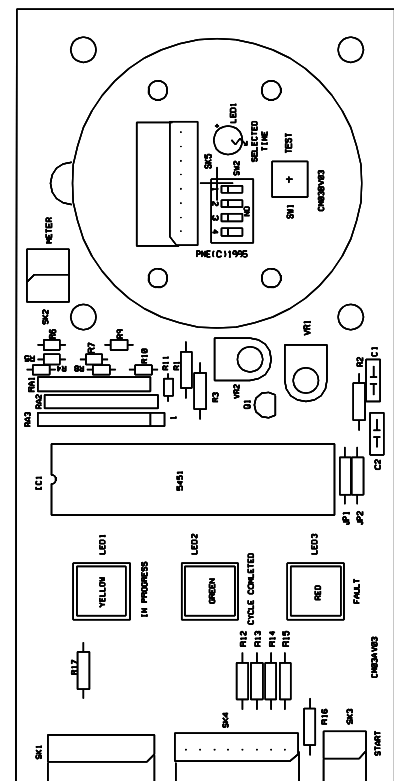
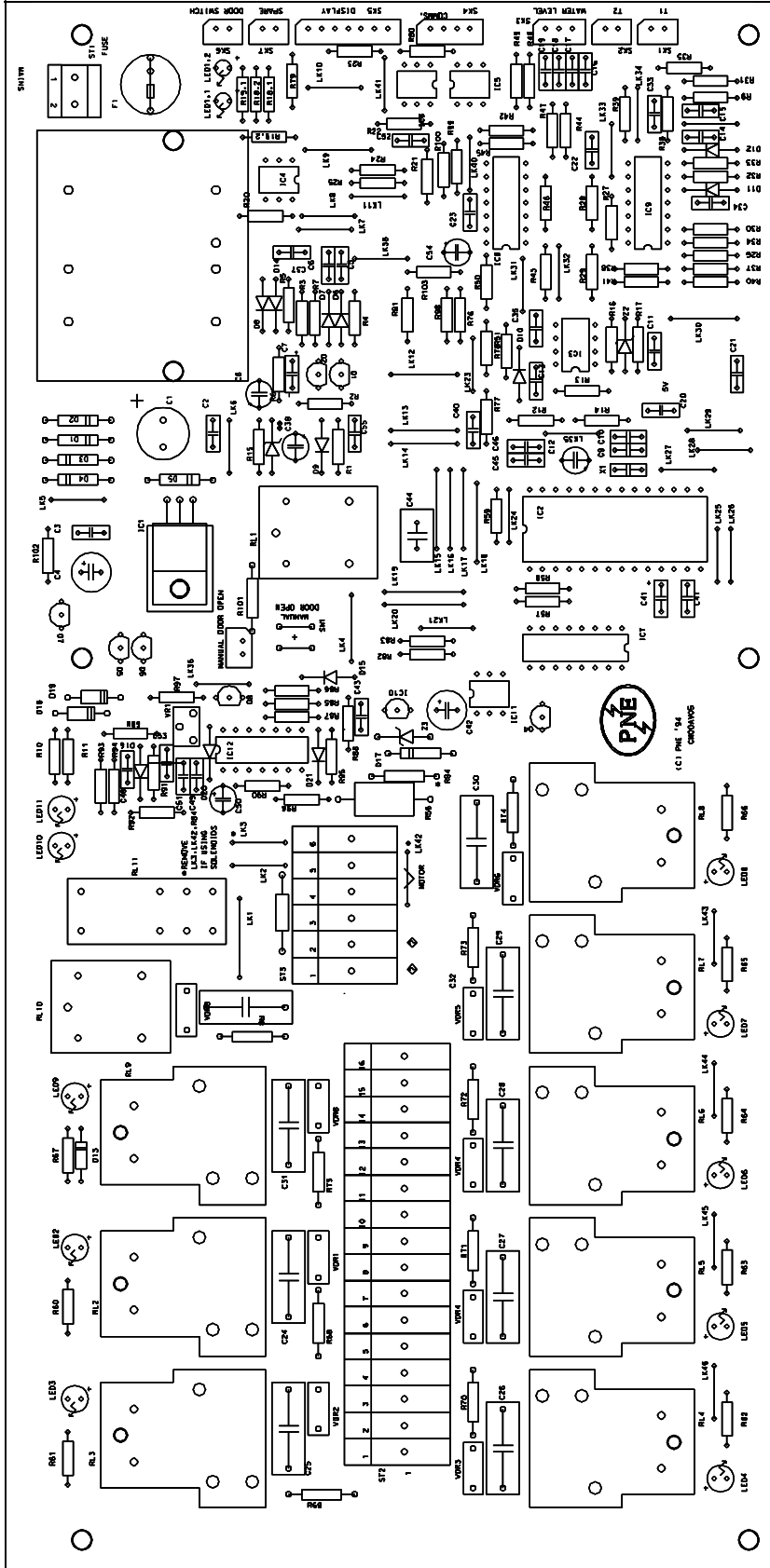



Operation, Maintenance and Installation Manual

Wiring Diagram

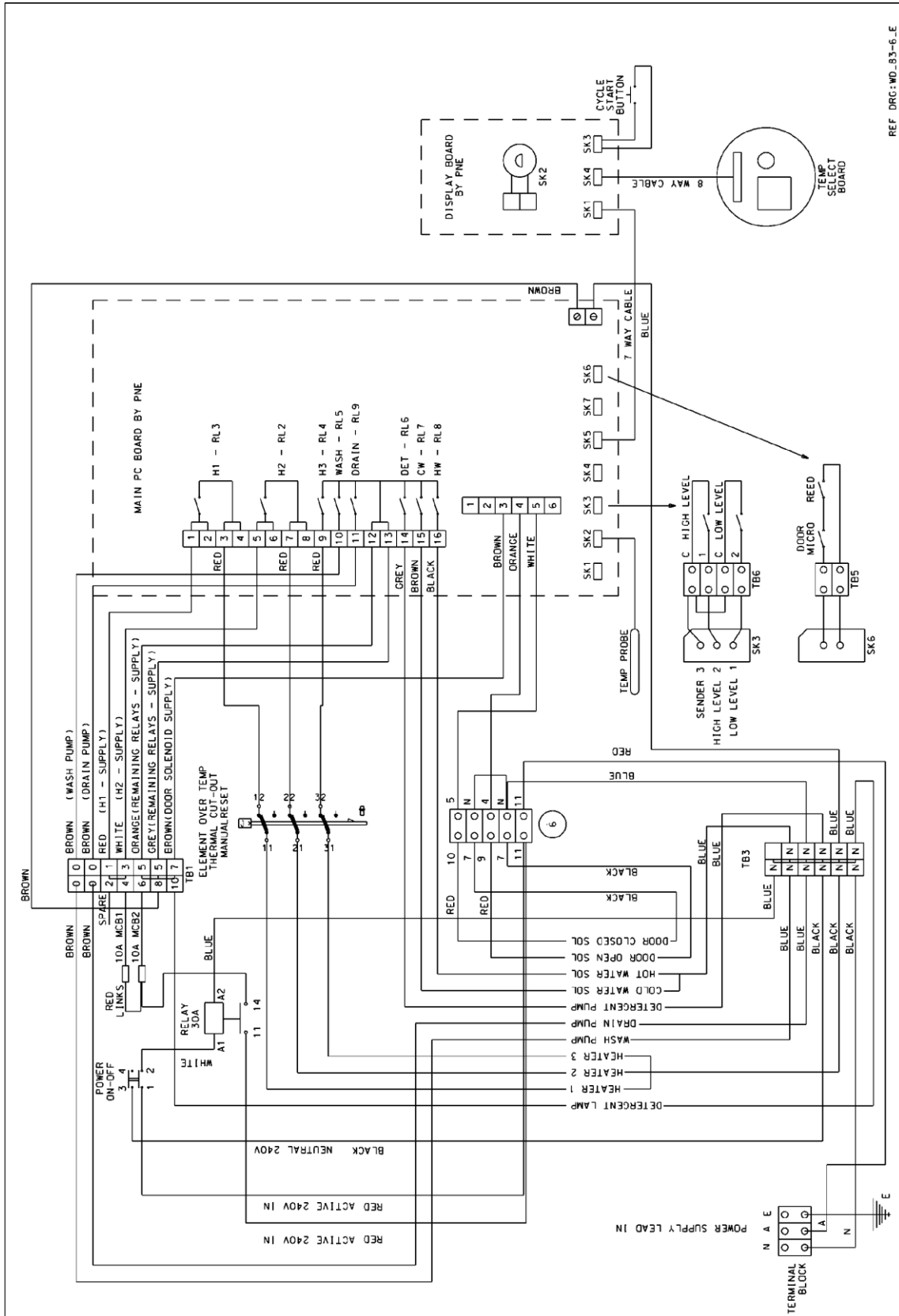

REF. DRG: WD.83-6_E



Operation, Maintenance and Installation Manual

Fault Finding Guide

Fault Indicated

The 'FAULT INDICATED' light will be switched on if the total cycle time exceeds one hour or a fault is detected.

Check the input water temperature if the cycle time exceeds 80 minutes.

PCB Repair

Computer circuits, while robust, are not designed for human fingers etc to be placed across the pins.

Handle all circuit boards by the edges and do not touch components.

As an added precaution, always touch the metal frame of the Washer Disinfector before removing circuit boards. This allows for any static electricity to discharge to ground rather than through the PCB.

Please Note: Any unauthorised repair work carried out to the circuit boards will void any warranty on these components

Power Supply Check

As the first step of any fault finding, check the power supply to the unit and that the water taps are open.

If the fault still exists, remove the front cover of the Washer Disinfector to expose the circuit board and power cable loom.

The next stage of fault finding is to test the computer board power supplies.

1. Check for 240V AC between TB1-4 and TB3-2, TB1-6 and TB3-2. If this is absent then check for open circuit on mains supply.
2. Check for 240V across ST1 mains connection at top right hand side of main PCB.
3. Check fuse F1 located under ST1 for continuity.
4. Check fuse for 5V DC at the right hand pin of the 7805 voltage regulator. If no voltage is detected, the main PCB requires service.

If all tests prove correct, then the main PCB has all the correct voltages to operate. The next stage is to test the various sensors and switches which provide input to the main PCB.



Operation, Maintenance and Installation Manual

PCB Input checks (Please read in conjunction with PCB layout diagram)

Door Lock and catch

Remove SK6 on main PCB and test for continuity between the two pin plug with the door locked and catch locked.

High Water Level

Remove SK3 on main PCB and test for continuity between the top and middle pins.

Low Water Level

Remove SK3 on main PCB and test for continuity between the top and middle pins.
Check element over temp thermal switch for open circuit. Manual reset

Temperature Probe

Remove the temperature probe plug T2 and measure resistance across plug. Refer to Resistance Temperature Chart (refer page 18) for temperature readings.

Start Button

Remove SK3 on display PCB and test for continuity with the start button pressed. This check will involve the removal of the control panel to gain access to the display PCB which is behind the analogue temperature meter. It is not expected that in the normal sequence of checks that this check will be required.



Operation, Maintenance and Installation Manual

PCB Output Check

The circuit board has indication lights to show which output device should be switched on during the cycle as detailed below:

LED 1	Selected time (On bit switch board)
LED 2	Heater 1
LED 3	Heater 2
LED 4	Heater 3
LED 5	Wash / recirc pump
LED 6	Detergent pump
LED 7	Cold Water Solenoid
LED 8	Hot Water Solenoid
LED 9	Drain pump
LED 10	Power to Door Solenoid
LED 11	Selects between open and close
LED 1.1	Door is closed.

If the red indication light comes on and no action takes place, test the device separately from the PCB to confirm that it works.

If the pump, motor or solenoid works correctly, then the PCB needs repair.



Operation, Maintenance and Installation Manual

Resistance Temperature Chart

TEMP	THERMISTOR (OHMS)	TEMP	THERMISTOR (OHMS)	TEMP	THERMISTOR (OHMS)
-10.00	107.8E x 10 ³	27.00	20.3E x 10 ³	64.00	5.2E x 10 ³
-9.00	102.0E x 10 ³	28.00	19.5E x 10 ³	65.00	5.0E x 10 ³
-8.00	97.6E x 10 ³	29.00	18.7E x 10 ³	66.00	4.9E x 10 ³
-7.00	92.8E x 10 ³	30.00	18.0E x 10 ³	67.00	4.7E x 10 ³
-6.00	88.4E x 10 ³	31.00	17.3E x 10 ³	68.00	4.6E x 10 ³
-5.00	84.2E x 10 ³	32.00	16.6E x 10 ³	69.00	4.4E x 10 ³
-4.00	80.2E x 10 ³	33.00	16.0E x 10 ³	70.00	4.3E x 10 ³
-3.00	76.4E x 10 ³	34.00	15.4E x 10 ³	71.00	4.1E x 10 ³
-2.00	72.8E x 10 ³	35.00	14.8E x 10 ³	72.00	4.0E x 10 ³
-1.00	63.1E x 10 ³	36.00	14.2E x 10 ³	73.00	3.9E x 10 ³
0.00	66.2E x 10 ³	37.00	13.7E x 10 ³	74.00	3.8E x 10 ³
1.00	63.1E x 10 ³	38.00	13.2E x 10 ³	75.00	3.7E x 10 ³
2.00	60.2E x 10 ³	39.00	12.7E x 10 ³	76.00	3.5E x 10 ³
3.00	57.5E x 10 ³	40.00	12.2E x 10 ³	77.00	3.4E x 10 ³
4.00	54.9E x 10 ³	41.00	11.7E x 10 ³	78.00	3.3E x 10 ³
5.00	52.4E x 10 ³	42.00	11.3E x 10 ³	79.00	3.2E x 10 ³
6.00	50.1E x 10 ³	43.00	10.9E x 10 ³	80.00	3.1E x 10 ³
7.00	47.8E x 10 ³	44.00	10.5E x 10 ³	81.00	3.0E x 10 ³
8.00	45.7E x 10 ³	45.00	10.1E x 10 ³	82.00	2.9E x 10 ³
9.00	43.7E x 10 ³	46.00	9.8E x 10 ³	83.00	2.9E x 10 ³
10.00	41.8E x 10 ³	47.00	9.4E x 10 ³	84.00	2.8E x 10 ³
11.00	40.0E x 10 ³	48.00	9.1E x 10 ³	85.00	2.7E x 10 ³
12.00	38.2E x 10 ³	49.00	8.8E x 10 ³	86.00	2.6E x 10 ³
13.00	36.6E x 10 ³	50.00	8.4E x 10 ³	87.00	2.5E x 10 ³
14.00	35.0E x 10 ³	51.00	8.2E x 10 ³	88.00	2.5E x 10 ³
15.00	33.5E x 10 ³	52.00	7.9E x 10 ³	89.00	2.4E x 10 ³
16.00	32.1E x 10 ³	53.00	7.6E x 10 ³	90.00	2.3E x 10 ³
17.00	30.8E x 10 ³	54.00	7.3E x 10 ³	91.00	2.3E x 10 ³
18.00	29.5E x 10 ³	55.00	7.1E x 10 ³	92.00	2.2E x 10 ³
19.00	28.2E x 10 ³	56.00	6.8E x 10 ³	93.00	2.1E x 10 ³
20.00	27.1E x 10 ³	57.00	6.6E x 10 ³	94.00	2.1E x 10 ³
21.00	26.0E x 10 ³	58.00	6.4E x 10 ³	95.00	2.0E x 10 ³
22.00	24.9E x 10 ³	59.00	6.2E x 10 ³	96.00	2.0E x 10 ³
23.00	23.9E x 10 ³	60.00	6.0E x 10 ³	97.00	1.9E x 10 ³
24.00	22.9E x 10 ³	61.00	5.8E x 10 ³	98.00	1.8E x 10 ³
25.00	22.0E x 10 ³	62.00	5.6E x 10 ³	99.00	1.8E x 10 ³
26.00	21.1E x 10 ³	63.00	5.4E x 10 ³	100.00	1.7E x 10 ³



Section C – Unit Installation

Please Note Installations must be carried out by qualified and licensed tradespeople.

Service Connections

Service Connections required for the Top Loading Washer Disinfector are:

Cold Water	G ³ / ₄ " BSP flexible hose (supplied)
Hot Water	G ³ / ₄ " BSP flexible hose (supplied)
Drain	1" flexible hose to Tundish (supplied) refer to Service Connection Layout Diagram
Electrical	WDT2 – 240V single phase draws 18 Amps 50 Hz

Note¹: New Hose sets supplied with the unit are to be used. Old hose sets should not be re-used.

Note²: The Service Connections may be on either side of the washer but not behind it. On the unit all water and drain connections are on the left hand side when facing the unit, however they can be quite simply moved to the right hand side as follows:

- i. Remove the rear panel.
- ii. Remove the three plastic plugs from the holes in the right hand back panel.
- iii. Unscrew the water inlet solenoid brackets.
- iv. Transfer the water inlet solenoids to the right hand back panel. Be sure to put the cold water solenoid to the top and the hot to the bottom. Tighten the brackets.
- v. Unscrew the waste outlet support.
- vi. Transfer the water outlet to the right hand back panel. It may be necessary to loosen the hose clamps and rotate the hose. When in position, tighten the support and the hose clamps.
- vii. Re-fit the plastic plugs to the three holes in the left hand back panel.
- viii. Re-fit the rear panel.

The electrical connections are in the centre of the bottom back panel.

Electrical

WDT2 requires single phase 240V draws 18 Amp 50 Hz. It is recommended that the unit be connected to a 20 Amp circuit breaker. All units must be earthed

Note:  Mains power ISO switch or plug connection must be in an accessible position so device can be isolated from mains power during service

Switch is to be fixed to the building wall (approximately 1200mm above floor level) adjacent to the Washer Disinfector's electrical entry point which is positioned at the rear of the unit in the centre of the bottom panel.

Note:  If the supply cord is damaged, it must be replaced by the manufacturer, its service agent or similarly qualified persons in order to avoid a hazard.



Operation, Maintenance and Installation Manual

Plumbing

NOTE:  Plumbing connections must comply to AS3500

Hot Water

All models can be connected direct to any hot water supply of at least 40°C minimum. For the quickest operating cycles water at 60°C is ideal. There is an airbreak incorporated within the unit. The hot water supply should be connected to a 15Ø hot water chrome plated isolating valve with GB³/₄" BSP male connection, placed above the unit and to the sides of the unit. The water entry point is on the left hand side of the unit as shown in the service connection diagram.

Minimum Inlet Water Pressure = 40 kPa
Maximum Inlet Water Pressure = 500 kPa

Cold Water

All models can be connected direct to any cold water supply. There is an airbreak incorporated within the unit. The water entry point is on the left hand side of the unit as shown in the service connection diagram.

Minimum Inlet Water Pressure = 40 kPa
Maximum Inlet Water Pressure = 500 kPa

Waste

The tundish supplied with the units is to suit left-hand waste connection. Where right hand connection is required, remove the tundish lid and reposition it to suit by rotating 180°.

The service connections diagram (Fig 1) shows left-hand connection.

The maximum discharge temperature of the unit is 90°C. 50mm Combination S & P trap supplied with the unit is of Polypropylene material and can withstand temperatures of up to 90°C.



Operation, Maintenance and Installation Manual

Service Connection Layout Diagram

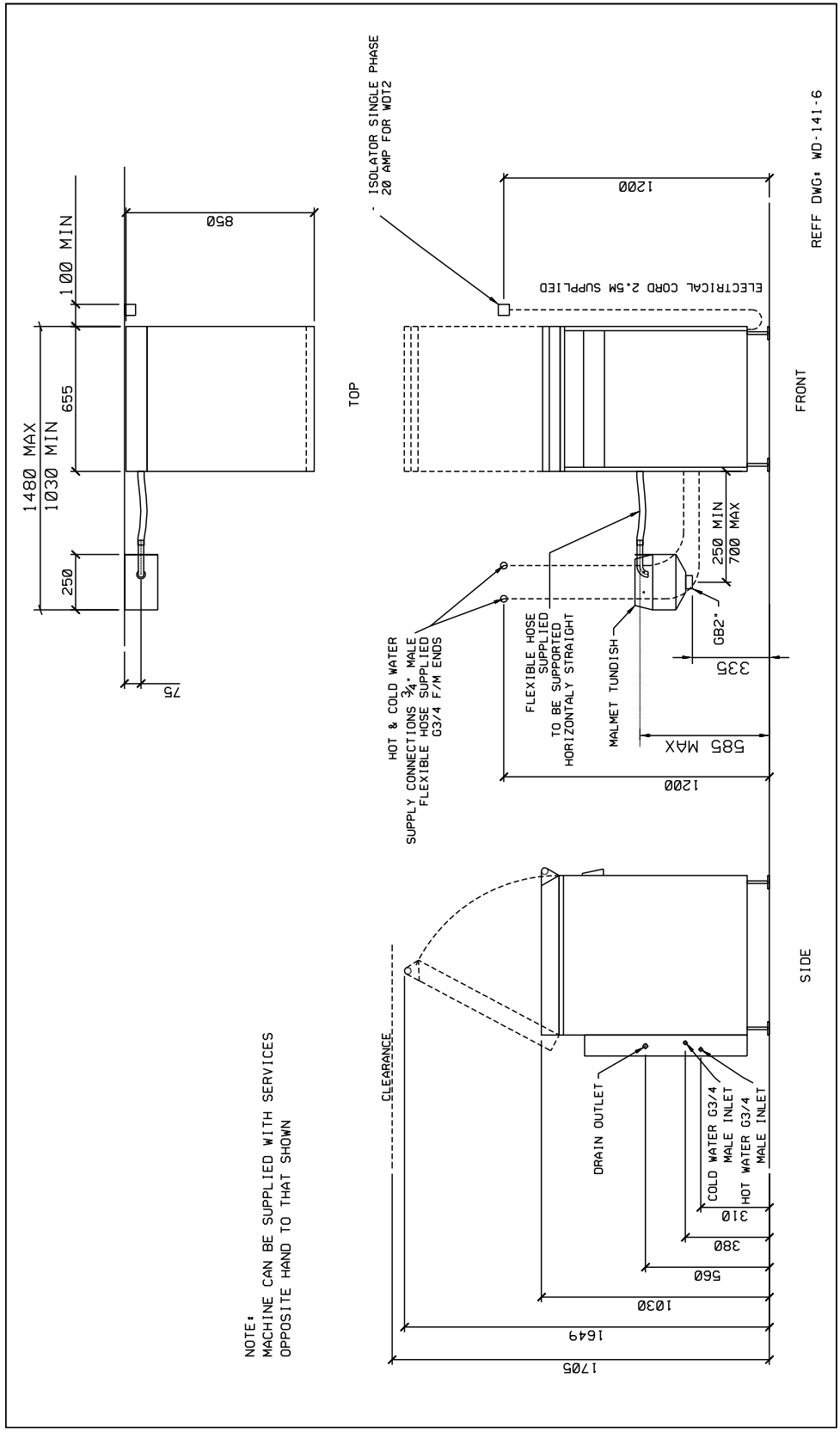



Operation, Maintenance and Installation Manual

Unit Specifications

POWER AND WATER CONSUMPTION DATA						
MODEL	Disinfection Time Settings	Avg Cycles per/Hr	Avg Cycle min/sec	Avg kWh per cycle	CW Avg Lt Per cycle	HW Avg Lt per cycle
						60c
WDT2	80c x 10min	0.7	41.30	1.480	34	50
	90c x 1min	0.7	42.48	1.725	34.	50
	75c x 30min	1	58.36	1.508	34	50

NOTE: Values may change due to operating and supply service conditions.

Electrical Rating	Volts	240V	APPROVALS
	Phase / Hz	1 ph / 50 Hz	
	Amps	18 Amps	
Environment operating conditions	Temperature	+10°C to +25°C	
	Relative Humidity	+30% to +70%	
Element	Rated	3.6 kW	
	Overtemp protection	Thermal cut-out switch 3 pole set point 115°C Manual reset	
Fuse F1: Main pcb	Cylinder type	T315mAL 250V	
PCB (Printed Circuit Board)		✓	
Temperature Control		Factory set at 80°C	
Disinfecting Times		58°C – 20 minutes	AS/NZS 4187:2003 – Section 10, Clause 10.2.1
		75°C – 30 minutes	
		80°C – 10 minutes	
		90°C – 1 minute	
Detergent	Malmet specific (5Lt)	Detergent Concentrate Caustic Alkaline	ARTGC Class 1
Backflow Prevention	Air Gap (RAG)		AS 2845.2 - 1996
Water Supply Cold	Temp – Pressure (Static)	5 - 25°C @ 40 – 500 kpa	
Water Supply Hot	Temp – Pressure (Static)	43 – 60°C @ 40 – 500 kpa	
Hot & Cold water Inlet sol Valves	Solenoid 240V	GB¾ male connection	WRAS Certified
Tundish End Connection to Waste	Combination S – P Trap	90°C PP	Cert to AS/NZS1260:2002
Hoses – Inlet Valve to Water Tank	s/steel Braided	10mm	WRAS Certified
Hoses – Water Supply to Inlet Valve	s/steel Braided Assy H/C Water	G¾ Hex Nut Each End	Cert to AS/NZS 3499-2006
Water Capacity		18.5 Litres	
Materials	Wash chamber and external panels	304/4 stainless steel	
Environment conditions Transport and Storage	Fragile	Keep away from rain	Do not stack
	Temperature	-5°C to +50°C	



Operation, Maintenance and Installation Manual



Malmart (Australia) Pty Ltd

Website: www.malmart.com.au



Warranty Statement

Subject to the following conditions, we provide, from the date of purchase, the following warranty on Malmart units and spare parts:

- Functional components found within the unit to be defective in workmanship or material will be repaired or replaced free of charge subject to the periods of warranty specified.
- A decision regarding whether the defective components will be repaired or replaced will be determined at the sole discretion of Malmart (Australia) Pty Ltd (“Malmart”) or its authorized agents or representatives.
- The structural warranty covers any structural components within the unit, which fail to perform their intended function due to faulty manufacture or deterioration within the warranty period.

This warranty only covers products manufactured by Malmart.

This warranty covers Australia Only.

Parts replaced in units under warranty are warranted for the balance of the original warranty period for that unit.

Malmart Units	
Unit Components	Parts & Labour
Structural Guarantee	1 Year from Date of Purchase
All other components	1 Year from Date of Purchase of unit
Malmart Spare Parts	
1 year from Date of Purchase	

This warranty is provided, and operates in addition to, the statutory warranties Malmart provides you as a consumer under the Australian Consumer Law or by virtue of any other applicable legislation.

CONDITIONS AND EXCLUSIONS

- Equipment must be installed according to our instructions (outlined in our Operation, Maintenance and Installation Manual) and operated to the purpose it was designed.
- To the extent permitted by law, this warranty shall not cover damage, malfunction or failure resulting from accident, misuse or misapplication, improper or unauthorised repair, neglect or modification or use of unauthorised replacement parts or accessories, inclusive of detergent, or improper voltage. The warranty shall be void if the serial number is removed or altered.



Operation, Maintenance and Installation Manual

- Parts damaged in transit back to Malmet Leeton due to poor packaging could result in warranty claim being rejected.
- Any part tampered with or which has been altered by unauthorised repairs and or modifications, will be rejected under a warranty claim.
- Reasonable access must be allowed for maintenance. If any additional equipment is needed to provide access to the unit, this must be provided (and paid for) by the owner.
- It is the owner's responsibility to provide safe access to the unit. Malmet, or any of its authorised service outlets, may refuse to perform maintenance or warranty work if access is unsafe, as determined by Malmet or any of its authorized service outlets at their sole discretion (acting reasonably).
- Should a warranty claim be rejected you will be advised in writing with a full explanation of our reasons.
- It is our policy to have a Warranty Claim Procedure that is fair to our customers and provides an efficient system of replacement and/or repair of faulty parts. If at any time you believe we are not meeting our commitment to you please contact Malmet Head Office – Leeton by telephone on (02) 6953 7677 or in writing to PO Box 373, Leeton NSW 2705.
- To the extent permitted by law, no responsibility will be accepted for outside elements including, but not limited to storms, pest and vermin that may cause damage to the unit.
- To the extent permitted by law, no responsibility will be accepted for damage incurred as a result of, or incidental to, electrical surges or brown outs or for any other consequential damages.
- If there is no certificate of compliance for plumbing or electrical, Malmet reserves the right to refuse service on non-compliant installations.
- To the extent permitted by law, claims for damage to contents, carpet, ceilings, foundations or any other consequential loss either direct or indirect resulting from, power spikes, incorrect operation, incorrect installation, faulty product or any other cause, are excluded.
- This warranty, and to the extent permitted by law, any warranties owed by Malmet under the Australian Consumer Law or other applicable legislation, are not transferrable and cannot be sold, assigned or transferred in any other way from the purchaser to any other person.
- To the extent permitted by law, unauthorised use of any parts that were not supplied or approved for use in the applicable unit by Malmet will result in this warranty and any warranty claims applicable to that unit being void.
- Warranty labour (service work) shall not include units located outside of city metropolitan areas. Costs outside these areas shall be borne by the Customer. The Customer shall be notified of this prior to the warranty call out.

To the extent permitted by law, a charge will be made for work done or a service call made where:

- There is no default apparent with the unit, as determined by Malmet or its authorized representative or agent at their sole discretion (acting reasonably).
- The defective operation of the unit is due to failure of electricity or water supply.
- Defects are caused by neglect, incorrect application, abuse or by accidental damage of the unit.
- An unauthorised person has attempted to repair the unit.



Operation, Maintenance and Installation Manual

- Harsh environmental situations including, but not limited to, water quality that may cause the water tank damage can not be considered warranty.

HOW TO MAKE A CLAIM UNDER THIS WARRANTY

If you believe there is a defect in a unit you have purchased from Malmet, you must notify Malmet in writing of such defect, by sending a letter ("**Notice of Defect**") to Malmet at PO Box 373, Leeton NSW 2705 prior to the expiration of the applicable warranty period set out in this warranty.

For the avoidance of doubt, Malmet must receive your Notice of Defect prior to the expiration of the warranty period, and will be deemed to receive such Notice of Defect one business day (in the state of New South Wales) after you post the Notice of Defect.

To the extent permitted by law, Malmet will not reimburse you for any expense you incur in claiming or attempting to make a claim for repair or replacement of a component under this warranty.

Date Sold: Warranty Expiry Date:

Sold To:

For Service Contact:

PROOF OF PURCHASE

It is important that the name of the distributor from whom you purchased your product and the name of the installer are recorded at the front page of this manual. The installer is responsible for the correct installation, start up and demonstrating the operation of this product. They are also responsible for issuing the relevant certificates of compliance (these may differ from state to state).

Please attach your proof of purchase. Your receipt/invoice is your warranty and will be required to validate any warranty.

E.&O.E.

In the interest of continued product improvement, Malmet (Australia) Pty Ltd reserves the right to alter specifications without notice.

AUSTRALIAN CONSUMER LAW DISCLAIMER:

Our goods come with guarantees that cannot be excluded under the Australian Consumer Law. You are entitled to a replacement or refund for a major failure and for compensation for any other reasonably foreseeable loss or damage. You are also entitled to have the goods repaired or replaced if the goods fail to be of acceptable quality and the failure does not amount to a major failure.



Manufactured by
Malmet (Australia)
ABN 95 001 717 791
www.malmet.com.au